

# HORIBA

## Instruction Manual

pH/ORP/CONDUCTIVITY METER

LAQUA-PC210

LAQUA-PC220

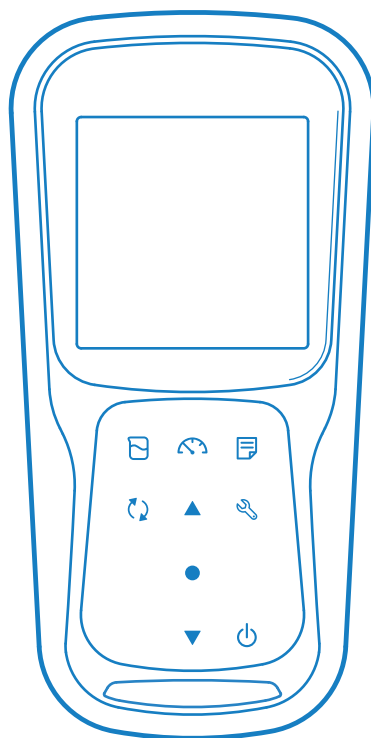

**LAQUA**  
Portable pH • Water Quality Meter



## Preface

This manual describes the operation of the following instrument.

Brand:	LAQUA
Series name:	LAQUA 200 Series Handheld Water Quality Meter
Model:	LAQUA-PC210, LAQUA-PC220
Model description:	pH/ORP/Conductivity Meter

Be sure to read this manual before using the product to ensure proper and safe operation of the product. Also, safely store the manual so it is readily available whenever necessary. Product specifications and appearance, as well as the contents of this manual are subject to change without notice.

### • Warranty and responsibility

HORIBA Advanced Techno Co., Ltd. warrants that the product shall be free from defects in material and workmanship and agrees to repair or replace free of charge, at option of HORIBA Advanced Techno Co., Ltd., any malfunctioned or damaged product attributable to responsibility of HORIBA Advanced Techno Co., Ltd. for a period of Three (3) years from the delivery unless otherwise agreed in a written statement. In any one of the following cases, none of the warranties set forth herein shall be extended:

- Any malfunction or damage attributable to improper operation
- Any malfunction attributable to repair or modification by any person not authorized by HORIBA Advanced Techno Co., Ltd.
- Any malfunction or damage attributable to the use in an environment not specified in this manual
- Any malfunction or damage attributable to violation of the instructions in this manual or operations in the manner not specified in this manual
- Any malfunction or damage attributable to any cause or causes beyond the reasonable control of HORIBA Advanced Techno Co., Ltd. such as natural disasters
- Any deterioration in appearance attributable to corrosion, rust, and so on
- Replacement of consumables

HORIBA Advanced Techno Co., Ltd. SHALL NOT BE LIABLE FOR ANY DAMAGES RESULTING FROM ANY MALFUNCTIONS OF THE PRODUCT, ANY ERASURE OF DATA, OR ANY OTHER USES OF THE PRODUCT.

### • Trademarks

- Microsoft, Windows, Windows Vista are registered trademarks or trademarks of Microsoft Corporation in the United States and other countries.

Other company names and brand names are either registered trademarks or trademarks of the respective companies. (R), (TM) symbols may be omitted in this manual.

# Regulations

- **Regulations**

- **EU regulations**

- **Conformable standards**

This equipment conforms to the following standards:



**EMC:** EN61326-1  
Class B, Basic electromagnetic environment

**RoHS:** EN50581  
9. Monitoring and control instruments

---

**Warning:** This product is not intended for use in industrial environments. In an industrial environment, electromagnetic environmental effects may cause the incorrect performance of the product in which case the user may be required to take adequate measures.

---

- **Information on disposal of electrical and electronic equipment and disposal of batteries and accumulators**

The crossed out wheeled bin symbol with underbar shown on the product or accompanying documents indicates the product requires appropriate treatment, collection and recycle for waste electrical and electronic equipment (WEEE) under the Directive 2012/19/EU, and/or waste batteries and accumulators under the Directive 2006/66/EC in the European Union. The symbol might be put with one of the chemical symbols below. In this case, it satisfies the requirements of the Directive 2006/66/EC for the object chemical. This product should not be disposed of unsorted household waste. Your correct disposal of WEEE, waste batteries and accumulators will contribute to reducing wasteful consumption of natural resources, and protecting human health and the environment from potential negative effects caused by hazardous substance in products.

Contact your supplier for information on applicable disposal methods.

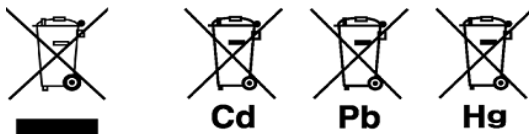

- **Authorised representative in EU**

HORIBA Europe GmbH  
Hans-Mess-Str.6, D-61440 Oberursel, Germany

# Regulations

---

## • FCC rules

### FCC Compliance Statement

This device complies with part 15 of the FCC Rules. Operation is subject to the following two conditions: (1) This device may not cause harmful interference, and (2) this device must accept any interference received, including interference that may cause undesired operation.

### Responsible Party for FCC matter

HORIBA Instruments Incorporated  
Head Office  
9755 Research Drive  
Irvine, California 92618 USA  
+1 949 250 4811

### Note

This equipment has been tested and found to comply with the limits for a Class A digital device, pursuant to part 15 of the FCC Rules. These limits are designed to provide reasonable protection against harmful interference when the equipment is operated in a commercial environment. This equipment generates, uses, and can radiate radio frequency energy and, if not installed and used in accordance with the instruction manual, may cause harmful interference to radio communications. Operation of this equipment in a residential area is likely to cause harmful interference in which case the user will be required to correct the interference at his own expense.

Any changes or modifications not expressly approved by the party responsible for compliance could void the user's authority to operate the equipment.

## • Korea certification

### B급 기기 (가정용 방송통신기자재)

이 기기는 가정용(B 급) 전자파적합기기로서 주로 가정에서 사용하는 것을 목적으로 하며, 모든 지역에서 사용할 수 있습니다.

## • Taiwan battery recycling marks



廢電池請回收

# Regulations

---

## • China regulation

### 标记的意义 Meaning of Marking

本标记适用在中华人民共和国销售电器电子产品，标记中央的数字表示环境保护使用期限的年数。（不是表示产品质量保证期间。）只要遵守这个产品有关的安全和使用注意事项，从制造日开始算起在这个年限内，不会给环境污染、人体和财产带来严重的影响。请不要随意废弃本电器电子产品。



This marking is applied to electric and electronic products sold in the People's Republic of China. The figure at the center of the marking indicates the environmental protection use period in years. (It does not indicate a product guarantee period.) It guarantees that the product will not cause environment pollution nor serious influence on human body and property within the period of the indicated years which is counted from the date of manufacture as far as the safety and usage precautions for the product are observed. Do not throw away this product without any good reason.

# Regulations

产品中有害物质的名称及含量

Name and amount of hazardous substance used in a product

部件名称 Unit name	有害物质 Hazardous substances					
	铅 Lead (Pb)	汞 Mer- cury (Hg)	镉 Cad- mium (Cd)	六价铬 Hexa- valent chromium (Cr (VI))	多溴联苯 Poly bromobi- phenyl (PBB)	多溴二苯醚 Poly bromo- diphenyl ether (PBDE)
本体 Main unit	×	○	○	○	○	○
电池 Battery	×	○	○	○	○	○
AC 适配器 AC adopter <sup>*1,*2</sup>	×	○	○	○	○	○
电缆 Cable <sup>*2</sup>	×	○	○	○	○	○
支架 Stand <sup>*2</sup>	○	○	○	○	○	○
打印机 Printer <sup>*2</sup>	×	○	○	○	○	○
电极 Electrode <sup>*2</sup>	×	○	×	○	○	○

本表格依据 SJ/T 11364 的规定编制。

This form is prepared in accordance with SJ/T 11364.

○：表示该有害物质在该部件所有均质材料中的含量均在 GB/T 26572 规定的限量要求以下。

Denotes that the amount of the hazardous substance contained in all of the homogeneous materials used in the component is below the limit on the acceptable amount stipulated in the GB/T 26572.

×：表示该有害物质至少在该部件的某一均质材料中的含量超出 GB/T 26572 规定的限量要求。

Denotes that the amount of the hazardous substance contained in any of the homogeneous materials used in the component is above the limit on the acceptable amount stipulated in the GB/T 26572.

\*1: 本部件的环保使用期限为 10 年。 The environmental protection use period of this product is 10 years.

\*2: 选配件 Optional products

# For Your Safety

---

- **For Your Safety**

- **Hazard classification and warning symbols**

Warning messages are described in the following manner. Read the messages and follow the instructions carefully.

- **Hazard classification**

 **DANGER**

This indicates an imminently hazardous situation which, if not avoided, will result in death or serious injury. This is to be limited to the most extreme situations.

 **WARNING**

This indicates a potentially hazardous situation which, if not avoided, could result in death or serious injury.

 **CAUTION**

This indicates a potentially hazardous situation which, if not avoided, may result in minor or moderate injury. It may also be used to alert against unsafe practices.

- **Warning symbols**



Description of what should be done, or what should be followed.



Description of what should never be done, or what is prohibited.



## For Your Safety

---

### • Safety precautions

This section provides precautions for using the product safely and correctly and to prevent injury and damage. The terms of DANGER, WARNING, and CAUTION indicate the degree of immanency and hazardous situation. Read the precautions carefully as it contains important safety messages.

### • Instrument and electrode

## WARNING



Do not disassemble or modify the instrument. Otherwise, it may heat up or be ignited resulting in a fire or an accident.

## CAUTION



### **Harmful chemicals**

Some electrodes are used with hazardous standard solutions. Handle them with care. The internal solution of pH electrode is highly concentrated potassium chloride (3.33 mol/L KCl). If the internal solution comes in contact with the skin, wash it off immediately. If it gets into the eyes, flush with plenty of water and then consult a doctor.



### **Broken glass**

Broken glass may cause injury. The outer tube and tip of an electrode are made of glass. Handle them with care.



Do not use the phono jack under wet or humid conditions. Otherwise, it may cause a fire, electric shock, or breakage.

## For Your Safety

---

### • Battery

### WARNING



Keep batteries out of reach of children. If someone accidentally swallows a battery, consult a doctor immediately.



If alkaline fluid from a battery gets into the eyes, do not rub the eyes, rinse with clean water immediately and then consult a doctor. Contact with alkaline fluid could cause blindness.



Do not put batteries in a fire, expose to heat, disassemble or remodel. Doing so can cause fluid leakage, overheating or explosion.

# Product Handling Information

---

## • Product Handling Information

### • Operational precautions (instrument)

- Only use the product including accessories for their intended purpose.
- Do not drop or physically impact the instrument.
- The instrument is made of solvent-resistant materials but that does not mean it is resistant to all chemicals. Do not expose the instrument in strong acid or alkali solution, or wipe with such solution.
- If the instrument is dropped into water or gets wet, wipe it using soft cloth. Do not heat to dry it.
- The instrument has a dust-proof and waterproof structure i.e., the instrument does not malfunction even when immersed in water of 1 m depth for 30 minutes. This does guarantee non-destructive, trouble-free, dust-proof, and waterproof performance in all situations.
- When replacing the batteries or when a serial cable connected, the instrument does not have the dust-proof and waterproof performance. The dust-proof and waterproof performance is maintained only when the covers are attached correctly.
- After replacing the batteries or removing the serial cable connected, make sure that the waterproof gasket attached to the cover is not deformed or discolored, or has foreign matter adhering to it. If the waterproof gasket is deformed, discolored or has foreign matter adhering to it, dust could get inside, water leaks could occur that could lead to instrument malfunction.
- To disconnect an electrode or serial cable, hold the connector and pull it off. If you pull at the cable, it may cause breakage.
- The phono jack communication between the instrument and a personal computer (referred to as PC in the rest of this document) may fail because of environmental conditions, such as electromagnetic noise.
- Do not replace the batteries in a dusty place or with wet hands. Dust or moisture could get inside the instrument, possibly causing instrument malfunction.
- Do not use an object with a sharp end to press the keys.
- If the power supply is interrupted while measurement data is being saved in the instrument, the data could be corrupted.
- A Ni-MH rechargeable battery can be used in this instrument.

### • Operational precautions (battery)

- Do not short circuit a battery.
- Position the + and – side of the battery correctly.
- When the battery has depleted or the instrument will not be used for a long time, remove the batteries.
- Of the specified battery types, make sure to use two batteries of the same type.
- Do not use a new battery together with a used battery.
- Do not use a fully charged nickel-metal hydride battery together with a partially charged battery.
- Do not attempt to charge a non-rechargeable battery.

# Product Handling Information

---

## • Environmental conditions for use and storage

- Temperature: 0 °C to 45 °C
- Humidity: under 80% relative humidity and free from condensation

## • Avoid the following conditions:

- Strong vibration
- Direct sunlight
- Corrosive gas environment
- Locations close to an air-conditioner
- Direct wind

## • Transportation

When transporting the instrument, repackage it in the original package box. Otherwise, it may cause instrument damage.

## • Disposal

- Standard solution used for the calibration must be under neutralized before the disposal.
- When disposing of the product, follow the related laws and regulations of your country for disposal of the product.

# Contents

---

■ Product Overview .....	1
● Package Content.....	1
● Key Features .....	2
● Product components.....	3
■ Basic operations.....	7
● Mode and measurement.....	9
■ Calibration.....	11
● pH Calibration .....	11
● ORP/mV Calibration.....	13
● Conductivity Calibration .....	15
● TDS calibration .....	18
● Salinity calibration.....	19
● Temperature Calibration .....	21
■ Data.....	23
● Data capture and storage.....	23
● Data transfer.....	24
■ Setup.....	25
● P1 pH setup .....	25
● P1 COND setup .....	29
● P2 TDS setup.....	36
● Data setup .....	43

## Contents

---

● General setup.....	50
● CLK setup.....	59
■ Maintenance and storage .....	64
● Maintenance and storage of the instrument .....	64
● Maintenance and storage of electrodes .....	65
■ Error messages and trouble shooting.....	67
■ Appendix .....	72
● Appendix 1 .....	72
● Appendix 2 .....	74
● Appendix 3 .....	74

## ■ Product Overview

This section describes the package content, key features and product components of LAQUA PC200 handheld meters.

### ● Package Content

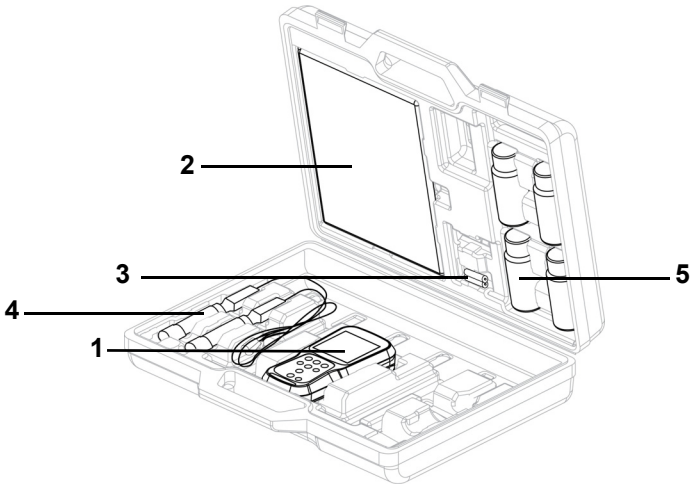

After opening the carry case, remove the meter and check for damage on the instrument and confirm that the standard accessories all exist. If damage or defects are found on the product, contact your dealer.

LAQUA PC200 Series Handheld meter and meter kit include the following items:

S.NO.	Name
1	Instrument
2	Instruction manual
3	2 AA batteries
4	Electrodes
5	Calibrating solutions

### ● Key Features

- IP67 water ingress, dust-proof, shock-resistant, anti-slip meter housing.
- Large monochrome LCD (50 x 50 mm) with white LED back lighting.
- Built-in electrode holder (up to 2 electrodes).
- Foldable meter stand.
- Simple user interface and single parameter display.
- 500 (for PC210) / 1000 (for PC220) data memory.
- Automatic Temperature Compensation (ATC) with temperature calibration.
- Adjustable auto shut-off time (1 to 30 minutes).
- Auto-hold / Auto stable / Real-time measurement modes with stability indicators.
- Powered by 2 x AA batteries.
- Real-time clock (only for PC220).
- PC (standard USB) / Printer (25 pin serial) connection via 2.5 mm diameter phono jack.





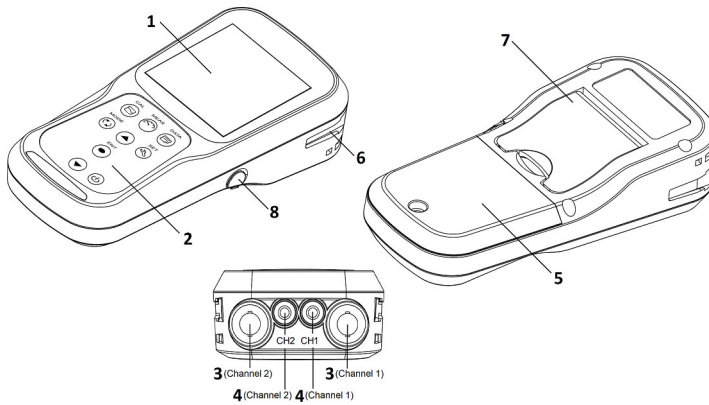



## ● Product components

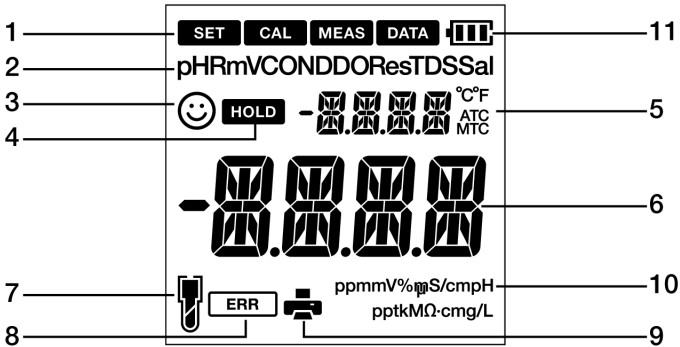





No	Name	Function
1	Monochrome LCD	Displays the measured value
2	Operation keys	Used for instrument operation
3	Electrode connector	Connect to the BNC connector of the electrode
4	Temperature connector (T)	Connect to the temperature sensor of the electrode
5	Battery cover	Open/close to insert/remove batteries
6	Electrode holder	Hold the electrode to carry with the instrument
7	Meter stand	Open stand to place the meter at an inclined position on a flat surface
8	Serial connector	Connects to the PC or printer with the appropriate cable

• Display





No	Name	Function
1	Status Icon	Displays the current operation mode (Setup, Calibration, Measurement and Data mode)
2	Parameters	Displays the measured parameters like pH, RmV, COND, Res, TDS and Sal
3		Stability indicator shows value is stable for documentation in Auto Stable and Auto Hold modes
4		Appears when the measured value display is stable and fixed in auto-hold mode
5	Temperature display area	Displays the measured temperature
6	Measured value, set item display area	Displays the measured value and the set value
7		Indicates electrode sensitivity level
8		Indicates error situation
9		Indicates data being transferred to the printer or computer
10	ppmmV%RH S/cm pH pptkMΩ-cmg/L	Displays the unit for the measurement parameter
11		Displays the battery level

- **Battery level display**

	100% battery life
	50% battery life
	20% battery life
	Batteries are weak and need replacement. Refer " BATT LOW " (page 67) to solve this

- **Electrode sensitivity level**

	Electrode sensitivity above 95%(excellent)
	Electrode sensitivity between 85% to 95% (very good)
	Electrode sensitivity between 80% to 85%(good). Refer " SLPE ERR " (page 67) to solve this

• **Keypad operation**

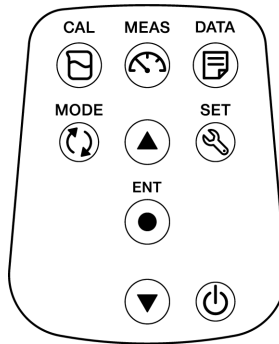

Keypad	Name	Function
	CAL key	Switches from the measurement mode to the calibration mode. Starts calibration in the calibration mode.
	MEAS key	Switches the operation mode to the measurement mode. Releases the fixed measurement value mode in the auto hold mode and begins a fresh measurement.
	DATA key	Switches from the measurement mode to the data mode.
	MODE key	In the measurement mode, changes measurement parameters.
	SET key	Switches from the measurement mode to the setup mode.
	ENTER key	Determines the selection or setup. Saves data in the measurement mode and calibration mode.
	UP key	In the setup mode, navigates between various setups. Selects preferred option in some setup screens.
	DOWN key	Increases or decreases selected digit when entering numbers.
	POWER key	Powers ON/OFF the instrument.

## ■ Basic operations

This section describes function and basic operation method of each part of LAQUA PC200 handheld meter.

### ● Turning on the instrument

#### Inserting the batteries

This instrument is operated by batteries. You can use AA alkaline batteries or AA Ni- MH chargeable batteries. Perform the following procedure to insert batteries in the instrument.

1. Unscrew the battery cover on the back of the instrument counter-clock wise to unlock the battery cover.
2. Remove the battery cover and set the batteries inside.
3. Replace battery cover.
4. Screw the battery cover on the back of the instrument clockwise to lock the battery cover.

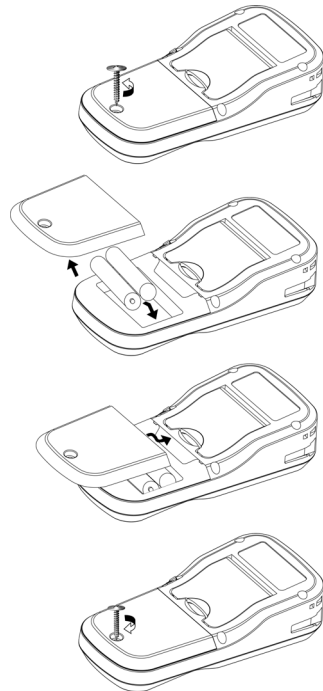

#### Note

- Do not replace the batteries in a dusty place or with wet hands. Dust or moisture could get inside the instrument and possibly cause an instrument malfunction.
- Do not short-circuit a battery.
- Note polarity as shown in the battery compartment.
- When the battery has depleted or the instrument is not used for a long time, remove the batteries.
- Of the specified battery types, make sure to use two batteries of the same type.
- Do not use a new battery together with an used battery.

● **Connecting an electrode**

To perform calibration/ measurement, it is necessary to use the appropriate electrode for measurement parameter. Recommended electrodes for various sample are listed in our product catalog. Use the following procedure to correctly connect the electrode to the instrument:

1. Insert the electrode connector by fitting its groove with the connector pin of the instrument (refer below table).
2. Turn the electrode connector clockwise by following the grooves.
3. Slide the connector cover on the connector.
4. When using a combination electrode equipped with a temperature sensor, insert the temperature jack (T) to the ATC socket on the meter.

CH1	CH2
pH Electrode	Conductivity Electrode

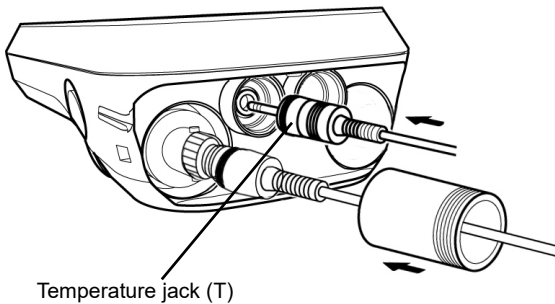
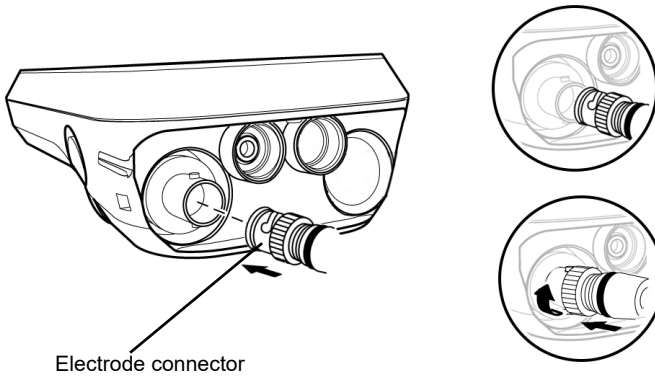





- **Mode and measurement**





- **Changing the operation mode**

You can change the operation mode to four available modes depending on the purpose of use. The status icon indicates the current mode.

Status icons —    

Icon	Name	Function
	Setup mode	Perform various setup functions.
	Calibration mode	Performs calibration.
	Measurement mode	Performs measurement.
	Data mode	Performs data setup. Displays the saved data.

You can change the operation mode using the corresponding key:

- **Measurement mode:** Press the  key to change to the measurement mode.
- **Calibration mode:** In the measurement mode, press the  key to change to the calibration mode.
- **Data mode:** In the measurement mode, press the  key to change to the data mode.
- **Setup mode:** In the measurement mode, press the  key to change to the setup mode.

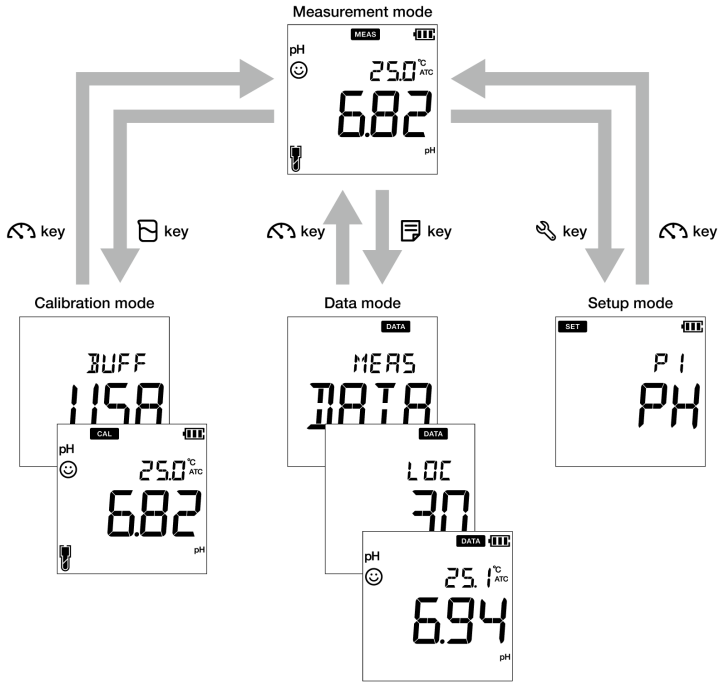

• **Changing the measurement parameter**

This instrument measures multiple parameters. For measurement, an electrode corresponding to the measurement parameter is required. In the measurement mode, the measurement parameter can be changed by pressing the key.

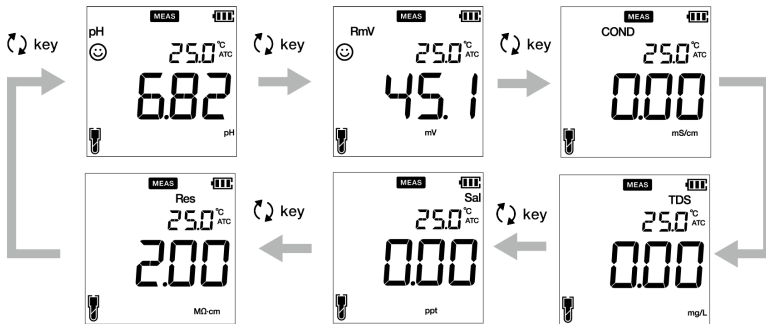



## ■ Calibration

This section describes the basic calibration method using LAQUA PC200 handheld meter, pH and conductivity electrode.

### ● pH Calibration

Calibration is necessary for accurate pH measurement. To perform pH calibration, follow the procedure detailed below:

#### Prerequisites

- Clean the pH electrode with DI (deionized) water and wipe it with tissue paper.
- Switch on the PC meter and plug in the pH electrode.
- Prepare buffer solution required for calibration.
- Keep the meter in pH measurement mode.
- Dip the pH electrode at least 3 cm in the calibration solution.

---

#### Note





- Perform two-point calibration using:
  - pH 7 and 4 for acidic sample.
  - pH 7 and 10 for alkaline sample.
- Perform three-point calibration using pH7, 4 and 10 if you are unsure of the expected sample pH value. It is recommended to calibrate with pH7 first.
- Default buffer setup is **BUFF USA**. If you want to change to **BUFF NIST** or **BUFF DIN**, refer to “P 1.1 Buffer selection” on page 26.

---

#### Tip

- To abort an ongoing calibration process at any point of time, press the  key.
  - It is recommended to clear the previous calibration data before performing calibration. For erasing the calibration data, refer to “P 1.3 Erase calibration data” on page 28.
-

### Calibration

1. After placing the pH electrode in the buffer solution, press the  key.
2. The selected buffer standard appears on the meter screen and meter starts checking various calibration values with a blinking  on screen.
3. Wait for the  to stabilize (stable calibration reading).
4. Press the **ENT**  key to confirm and save calibration data.
5. Meter displays **DONE** indicating end of the pH calibration procedure.

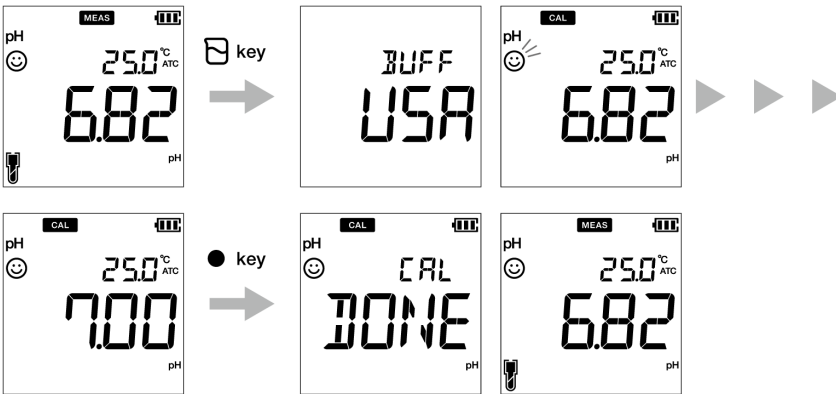

---

### Note

If you want to know previous calibrated values, press the  key when you are in the **CAL** mode. The display scrolls through the calibrated values and indicates slope and offset values.

---

---

## ● ORP/mV Calibration

Calibration is necessary for accurate ORP measurement. To perform ORP calibration, follow the procedure detailed below:

### Prerequisites

- Clean the ORP electrode with DI (deionized) water and wipe it with tissue paper.
- Switch on the PC meter and plug in the ORP electrode.
- Prepare standard solution required for calibration.
- Ensure that the meter is in mV measurement mode.
- Dip the ORP electrode into the standard solution ensuring that the solution level is at least 3 cm from the electrode tip.

---

### Note

- Absolute value measurement mode and relative value measurement mode are the two types of measurement mode available for ORP (mV) measurement.
  - In absolute value measurement mode, the handheld meter displays the actual voltage value.
  - In relative value measurement mode, user can adjust the absolute mV value by calibration. If the mV value is adjusted, the meter automatically indicates relative mV value as **RmV**. The adjustment mV is applied as an offset to the absolute mV value.
  - In the relative mV mode, the absolute mV value can be adjusted by  $\pm 200$  mV.
- 







---

### Tip

To abort an ongoing calibration process at any point of time, press the  key.

---

### Calibration

1. After placing the electrode in the solution, press the  key to switch to mV mode.
2. Press the  key.
3. Meter starts reading mV values and the  blinks until value stabilizes.
4. Wait for the  to stabilize (stable calibration reading).
5. Use the   keys to adjust the mV value to your desired value.
6. Press the **ENT**  key to confirm and save calibration data.
7. Meter displays **DONE** that indicates end of the ORP/mV calibration procedure.

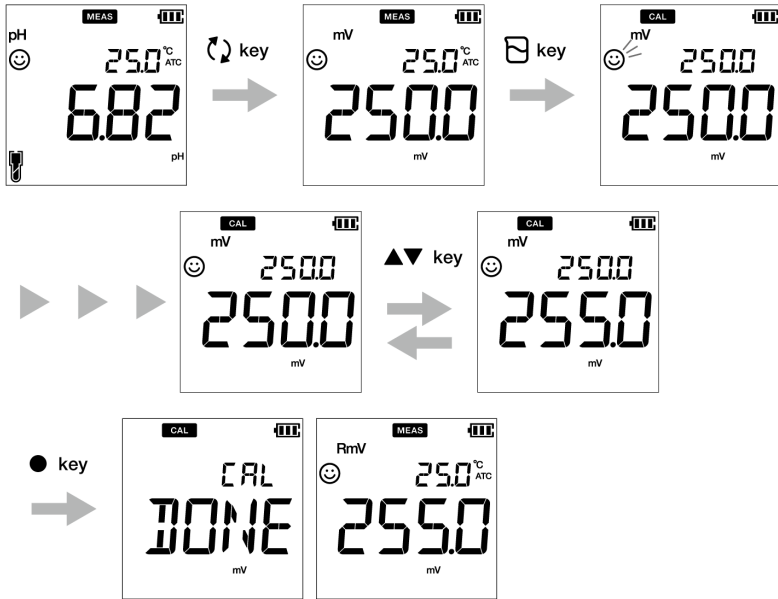

---

## ● Conductivity Calibration

Calibration is necessary for accurate electrical conductivity measurement. To perform conductivity calibration, follow the procedure detailed below:

### Prerequisites

- Clean the conductivity electrode with DI (deionized) water and wipe it with tissue paper.
- Switch on the PC meter and plug in the conductivity electrode.
- Prepare standard solution required for calibration.
- Press the  key to keep the meter in **COND** mode.
- Dip the conductivity electrode in the standard solution till the hole at the upper part of the electrode is immersed.

---

### Note

- Salinity, TDS, and resistivity of a sample solution are calculated from the measured value of conductivity.
- In conductivity calibration mode, the default calibration method is Auto calibration. If you like to change it to manual calibration method, refer “P 1.3 calibration mode setup” on page 32.





---

### Tip

- For second or multiple point calibration, clean the conductivity electrode with DI water and follow the same procedure.
  - If you are performing multiple point calibration, calibrate to the lowest conductivity first and then move to increasing conductivity values. This minimizes cross contamination.
  - To abort an ongoing calibration process at any point of time, press the  key.
-





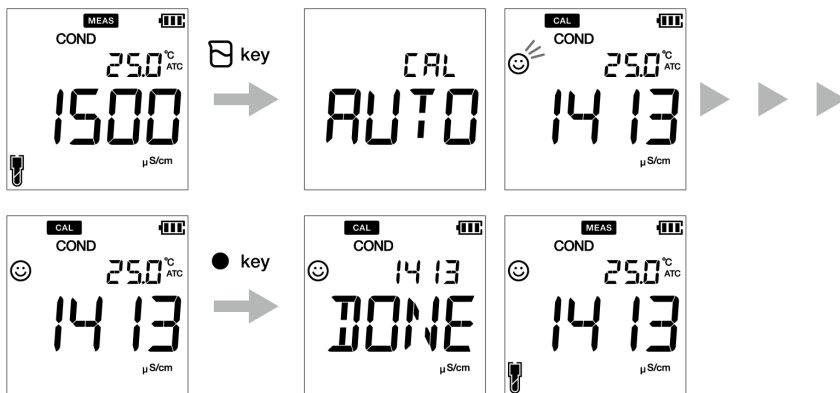

## Calibration

### Auto calibration

1. After placing the conductivity electrode in the standard solution, press the  key.
2. Meter displays “Auto cal” as per set calibration method and starts measuring various calibration values with a blinking  on screen.
3. Wait for the  to stabilize (stable calibration reading).
4. Press the **ENT**  key to confirm and save calibration data.
5. Meter displays **DONE** indicating end of the conductivity calibration procedure.
6. Repeat for other calibration points as required.
7. You can calibrate at one point for each range



**Manual calibration**

1. After placing the conductivity electrode in the standard solution, press the  key.
2. Meter displays “Manual cal” as per set calibration method and starts measuring various calibration values with a blinking  on screen.
3. Wait for the  to stabilize (stable calibration reading).
4. Use the   keys to enter the electrical conductivity value of the standard solution used for calibration.
5. Press the **ENT**  key to confirm and save calibration data.
6. Meter displays **DONE** indicating end of the conductivity calibration procedure.
7. Repeat for other calibration points as required.
8. You can calibrate at one point for each range.

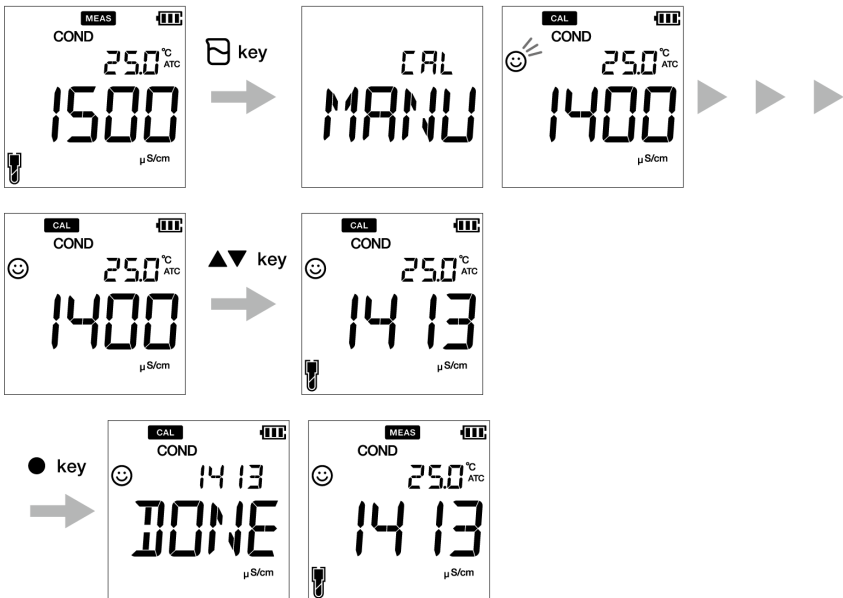

### • TDS calibration

TDS (Total dissolved solids) is calculated from the measured conductivity value. So no TDS calibration is required and once conductivity mode is calibrated, TDS values will be recalibrated accordingly.

Set the required TDS curve in LAQUA EC200 handheld meter. Available TDS curves are;

- **LINR** (Linear factor with adjustable factor from 0.4 to 1.0)
- **442** (Myron L 442 non-linear curve)
- **EN** (European environmental standard non-linear curve)
- **NACL** (non-linear salinity curve)

---

#### Note

---

To set a desired TDS method, refer “P 2.1 TDS curve selection” on page 37.

---



---

## • Salinity calibration

Calibration is necessary for accurate salinity measurement. To perform salinity calibration using LAQUA PC220 conductivity handheld meter, follow the procedure detailed below:

### Prerequisites

- Clean the conductivity electrode with DI (deionized) water and wipe it with tissue paper.
- Switch on the PC meter and plug in the conductivity electrode.
- Prepare standard solution required for calibration.
- Press the  key to keep the meter in **SAL** mode.
- Dip the conductivity electrode in the standard solution till the hole at the upper part of the electrode is immersed.

---

### Note







- Before salinity calibration, set the required salinity method. In LAQUA PC220 handheld meter, available salinity methods are;
    - **NACL**
    - **SEA.W** (Sea water)
  - To set a desired salinity method, refer "P 3.2 select salinity type" on page 41.
  - User can adjust the salinity value by calibration.
- 

---

### Tip

- For second or multiple point calibration, clean the conductivity electrode with DI water and follow the same procedure.
  - To abort an ongoing calibration process at any point of time, press the  key.
-

### Calibration

1. After placing the conductivity electrode in the standard solution, press the  key.
2. Meter starts measuring various calibration values with a blinking  on screen.
3. Wait for the  to stabilize (stable calibration reading).
4. Use the   keys to adjust the salinity value.
5. Press the **ENT**  key to confirm and save calibration data.
6. Meter displays **DONE** indicating end of the salinity calibration procedure.

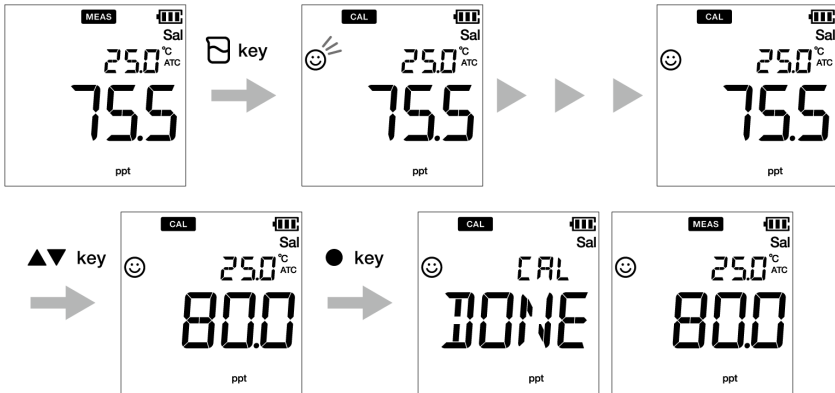

---

## • Temperature Calibration

Temperature calibration is required to accurately match pH or conductivity electrode to the meter. Check the temperature reading and if its acceptable, no temperature calibration is required. If you need to calibrate, please follow the procedure detailed below:

### Prerequisites

- Clean the pH or conductivity electrode with DI (deionized) water and wipe it with tissue paper.
- Switch on the PC meter and plug in the pH or conductivity electrode and the temperature sensor.
- Ensure to keep the PC meter in pH or mV measurement mode while using the pH electrode for temperature calibration and in COND or TDS or Sal measurement mode while using the conductivity electrode for temperature calibration.
- Dip the electrode in any calibration solution till its temperature sensor is immersed.
- Wait for 5 minutes to ensure temperature stability.

---

### Note

- Meter displays **MTC** if the temperature sensor is not plugged in and displays **ATC** if the temperature sensor is plugged in.
  - Temperature calibration must be performed using a known temperature solution or against a calibrated thermometer.
- 





---

### Tip

To abort an ongoing calibration process at any point of time, press the  key.

---

### Calibration

1. After placing the electrode in the solution, press the  key.
2. Press the  key to switch to temperature calibration mode. Meter displays measured temperature value.
3. Use the   keys to adjust the temperature to the required value.
4. Press the **ENT**  key to save calibration data.
5. Meter displays **DONE** indicating end of the temperature calibration procedure.

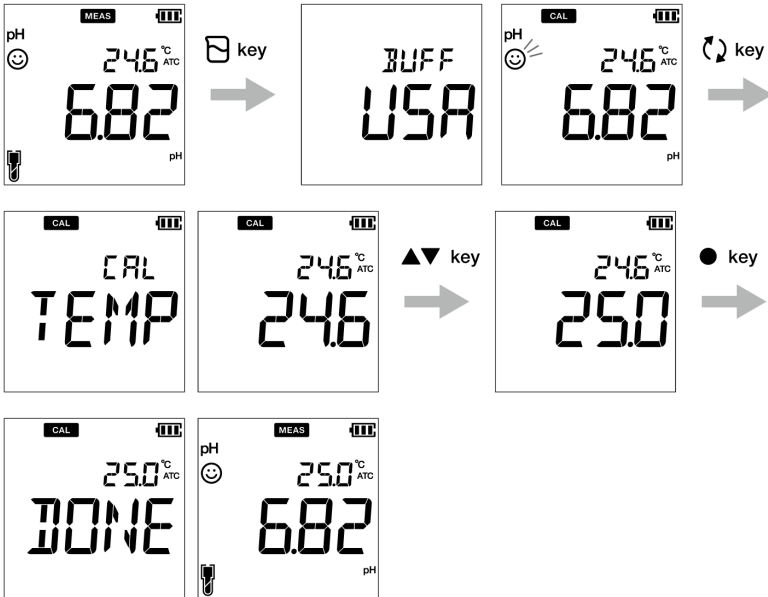

## ■ Data

This section describes the basic method of data storing and transferring using LAQUA 200 handheld meters.

### ● Data capture and storage

In LAQUA PC200 handheld meters, data measured by the instrument can be stored in the internal memory.

To save the measured data:

- Press the ENT ● key to save the displayed data.
- Meter displays the saved data for 2 seconds and then the display returns to the previous screen automatically.

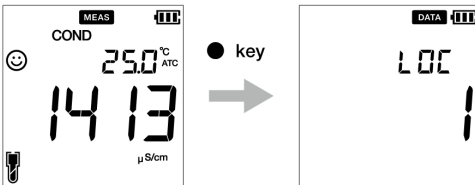

### Note

- If the data storage limit reaches 500 in PC210 model or 1000 in PC220 model, memory full error occurs and MEM FULL is displayed. To avoid memory full error, refer “Memory data full” on page 67.
- In such case, print the data or transfer necessary data to a PC (only for PC220) and delete the data from the internal memory of the instrument.

### Viewing stored data

- To view stored data, press key .
- Use ▲ ▼ keys to review different stored records.
- Press key to get back to measurement mode.

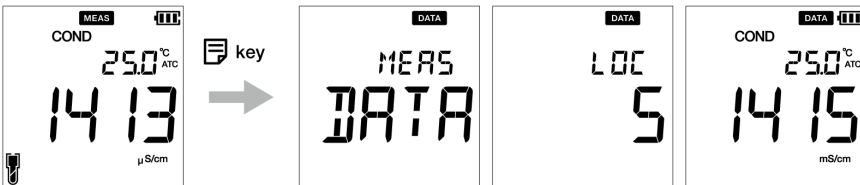





- **Data transfer**

- **Transfer data to PC**

Connect the instrument to a PC using phono jack to USB cable to transfer saved data to the PC (for LAQUA PC220 only). Connect the phono jack at the instrument side to the communication port on the PC.

- **Print data**

To print a desired data:

1. Being in the measurement mode, press  key.
2. Use   keys to view desired stored data.
3. Press  key to print that individual data.

- **Printer format- measurement**

### TDS

Meter Model	: HORIBA PC220
Serial Number	: 123456789
SW Revision	: 1.00
Date	: 20 Aug 2018
Time	: 10:10:28
Mode	: TDS
TDS	: 1.23 g/L
Temperature	: 25.0 C (MAN)
User Name	:
Signature	:

---

### Tip

---

To print entire stored data log, refer “Print data setup” on page 46.

---

## ■ Setup

This section describes all the setup functions available in LAQUA PC200 handheld meters.

### ● P1 pH setup

Using P1 pH setup function of the meter, you can:

- Select buffer standard
- Set calibration alarm
- Erase calibration data

To set the pH functions using LAQUA PC200 handheld meter, follow the procedure detailed below:

#### Prerequisites

Switch on the PC meter.

---

#### Note

- Default buffer setup is **BUFF USA**. You can change it to **BUFF NIST** or **BUFF DIN** if required.
  - Calibration alarm setup option must be used to avoid “Calibration interval alarm error” on page 67 . You can set the calibration alarm for ---- day to upto 90 days, where ---- indicates “no calibration alarm” has been set.
  - Erasing previous calibration data is recommended for accurate calibration. Default setup is **NO** but to erase the calibration data, you need to change the setup to **YES**.
- 







---

#### Tip

To return to the measurement mode, press the  key.

---





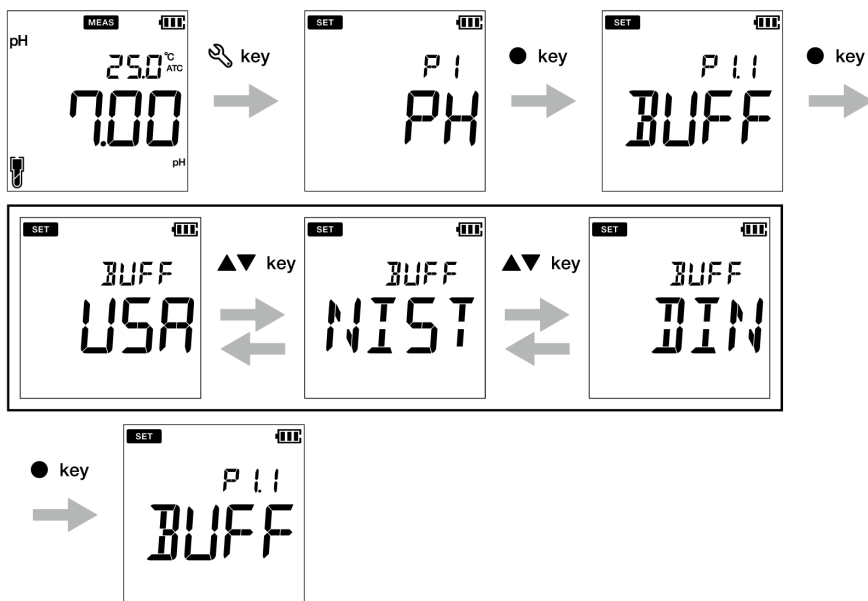

● **P 1.1 Buffer selection**

1. Press the  key, **P1 PH** screen appears.
2. Press the **ENT**  key, **P1.1 BUFF** screen appears.
3. Press the **ENT**  key, by default **BUFF USA** appears.
4. Use the   keys to change the buffer standard to **BUFF NIST** or **BUFF DIN**.
5. Press the **ENT**  key, **P1.1 BUFF** screen appears. This indicates completion of buffer selection.









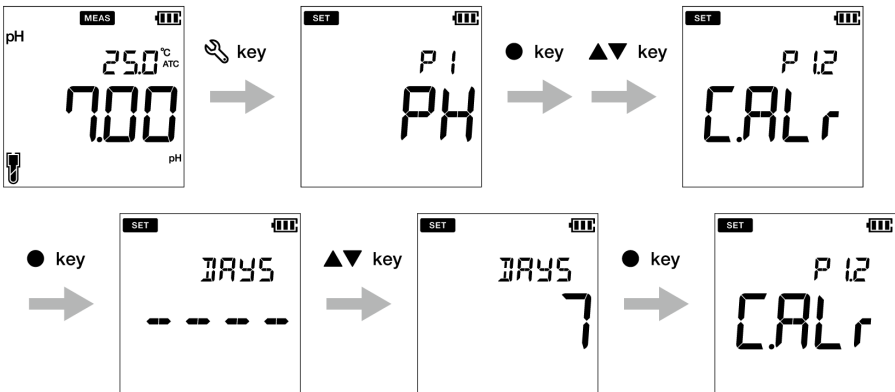



## ● P 1.2 Calibration alarm setup

1. Press the  key, **P1 PH** screen appears.
2. Press the **ENT**  key, **P1.1 BUFF** screen appears.
3. Press the  key, **P1.2 C.ALr** screen appears.
4. Press the **ENT**  key, by default **DAYS ----** appears.
5. Use the   keys to adjust the calibration alarm interval for next calibration.
6. Press the **ENT**  key, **P1.2 C.ALr** screen appears. This indicates completion of calibration alarm setup.



• P 1.3 Erase calibration data

1. Press the  key, P1 PH screen appears.
2. Press the  key, P1.1 BUFF screen appears.
3. Press the  key, P1.2 C.ALr screen appears.
4. Press the  key, P1.3 C.CLr appears.
5. Press the  key, C.CLr NO screen appears with NO as default setup.
6. Use the   keys to change the setup to YES. This erases the calibration data.
7. Press the  key. P1.3 C.CLr screen appears. This indicates erasure of calibration data.

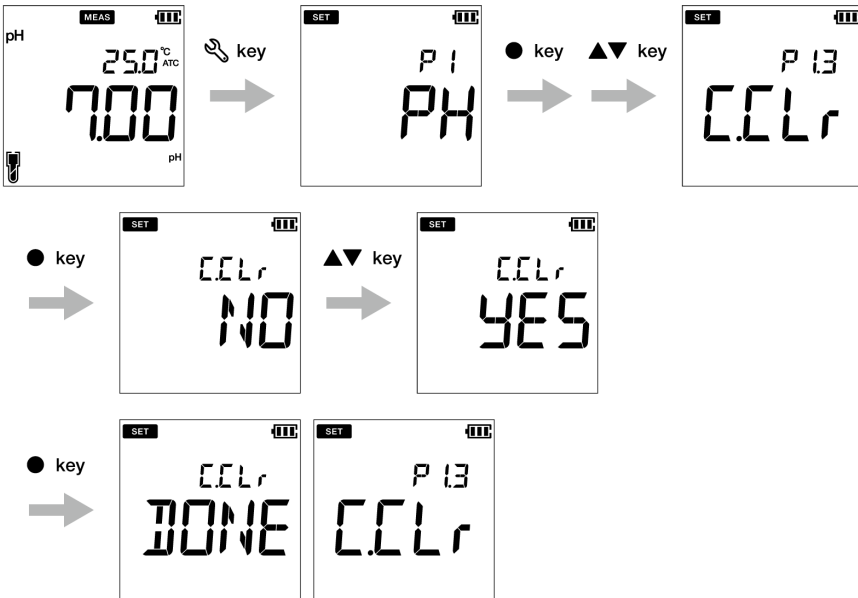

---

## • P1 COND setup

Using P1 COND setup function of the meter, you can:

- Set cell constant
- Select conductivity unit
- Set calibration mode
- Set temperature coefficient
- Set reference temperature
- Erase calibration data

To set the COND functions using LAQUA PC200 handheld meter, follow the procedure detailed below:

### Prerequisites

Switch on the PC meter.

---

#### Note

- Default cell constant value is **1.00** and you can set a value in between 0.070 to 13.00.
- Default conductivity unit is set as **S/cm**. You can change the unit to S/m.
- Default auto calibration setup is **ON** but to perform manual calibration, you need to change the setup to OFF.
- Default temperature coefficient is **2.00%**. You can set a value in between 0.00% to 10.00%.
- Default reference temperature is **25.0 °C**. You can set the value in between 15.0 °C to 30.0 °C.
- Erasing previous calibration data is recommended for accurate calibration. Default setup is **NO** but to erase the calibration data, you need to change the setup to **YES**.







---

#### Tip

To return to the measurement mode, press the  key.





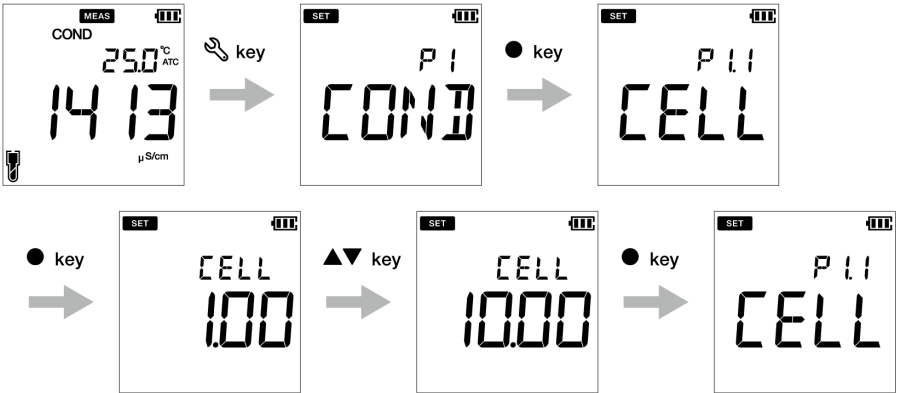

---

● P 1.1 Cell constant setup

1. Press the  key, P1 COND screen appears.
2. Press the  key, P1.1 CELL screen appears.
3. Press the  key, by default CELL 1.00 appears.
4. Use the   keys to set the cell constant in between 0.070 to 13.00.
5. Press the  key, P1.1 CELL screen appears. This indicates completion of cell constant setup.







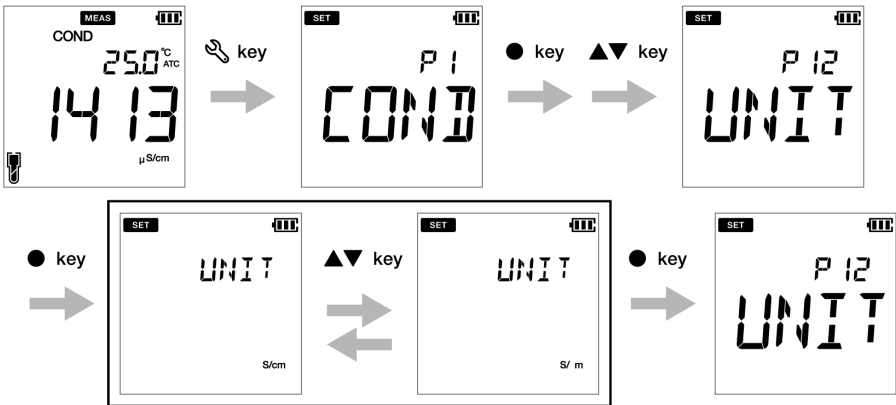



● **P 1.2 Select conductivity unit**

1. Press the  key, **P1 COND** screen appears.
2. Press the **ENT**  key, **P1.1 CELL** screen appears.
3. Press the  key, **P1.2 UNIT** screen appears.
4. Press the **ENT**  key, by default **UNIT S/cm** appears.
5. Use the   keys to change the conductivity unit to S/m.
6. Press the **ENT**  key, **P1.2 UNIT** screen appears. This indicates completion of conductivity unit selection.







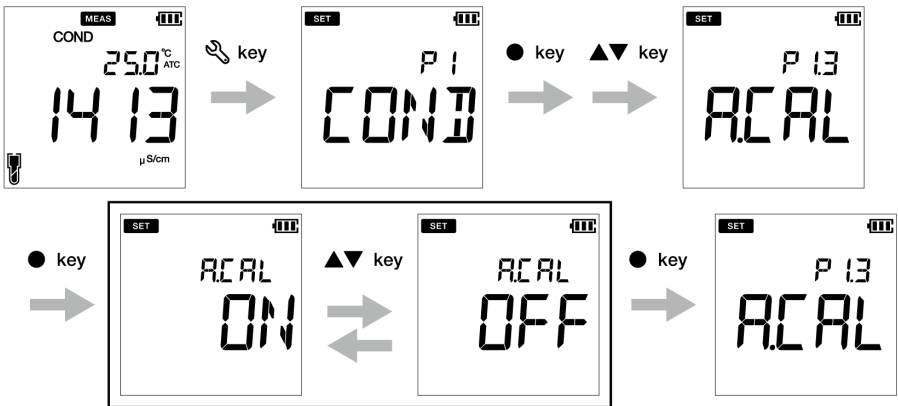



● **P 1.3 calibration mode setup**

1. Press the  key, **P1 COND** screen appears.
3. Press the **ENT**  key, **P1.1 CELL** screen appears.
4. Press the  key, **P1.2 UNIT** screen appears.
5. Press the  key, **P1.3 A.CAL** appears.
6. Press the **ENT**  key, **A.CAL ON** screen appears with **ON** as default setup.
7. Use the   keys to change the setup to **OFF**. This enables the manual calibration mode.
8. Press the **ENT**  key. **P1.3 A.CAL** screen appears. This indicates completion of auto calibration mode setup.







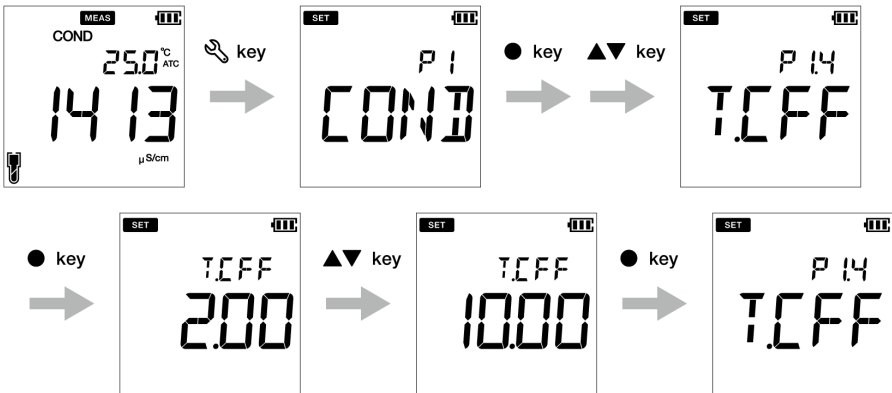





● **P 1.4 Temperature coefficient setup**

1. Press the  key, **P1 COND** screen appears.
2. Press the **ENT**  key, **P1.1 CELL** screen appears.
3. Press the  key, **P1.2 UNIT** screen appears.
4. Press the  key, **P1.3 A.CAL** appears.
5. Press the  key, **P1.4 T.CFF** appears.
6. Press the **ENT**  key, **T.CFF 2.00%** screen appears.
7. Use the   keys to set the temperature coefficient in between 0.00% to 10.00%.
8. Press the **ENT**  key. **P1.4 T.CFF** screen appears. This indicates completion of temperature coefficient setup.







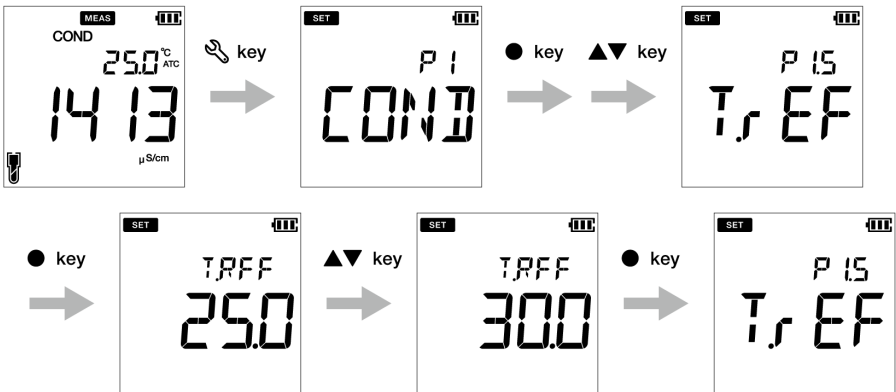





● **P 1.5 Reference temperature setup**

1. Press the  key, **P1 COND** screen appears.
2. Press the **ENT**  key, **P1.1 CELL** screen appears.
3. Press the  key, **P1.2 UNIT** screen appears.
4. Press the  key, **P1.3 A.CAL** appears.
5. Press the  key, **P1.4 T.CFF** appears.
6. Press the  key, **P1.5 T.rEF** appears.
7. Press the **ENT**  key, **T.REF 25.0 °C** screen appears.
8. Use the   keys to set the temperature coefficient in between 15.0 °C to 30.0 °C.
9. Press the **ENT**  key. **P1.5 T.rEF** screen appears. This indicates completion of reference temperature setup.





● **P 1.6 Erase calibration data**

1. Press the  key, **P1 COND** screen appears.
2. Press the **ENT**  key, **P1.1 CELL** screen appears.
3. Press the  key, **P1.2 UNIT** screen appears.
4. Press the  key, **P1.3 A.CAL** appears.
5. Press the  key, **P1.4 T.CFF** appears.
6. Press the  key, **P1.5 T.rEF** appears.
7. Press the  key, **P1.6 C.CLr** appears.
8. Press the **ENT**  key, **C.CLr NO** screen appears with **NO** as default setup.
9. Use the   keys to change the setup to **YES**. This erases the calibration data.
10. Press the **ENT**  key. **P1.6 C.CLr** screen appears. This indicates erasure of calibration data.

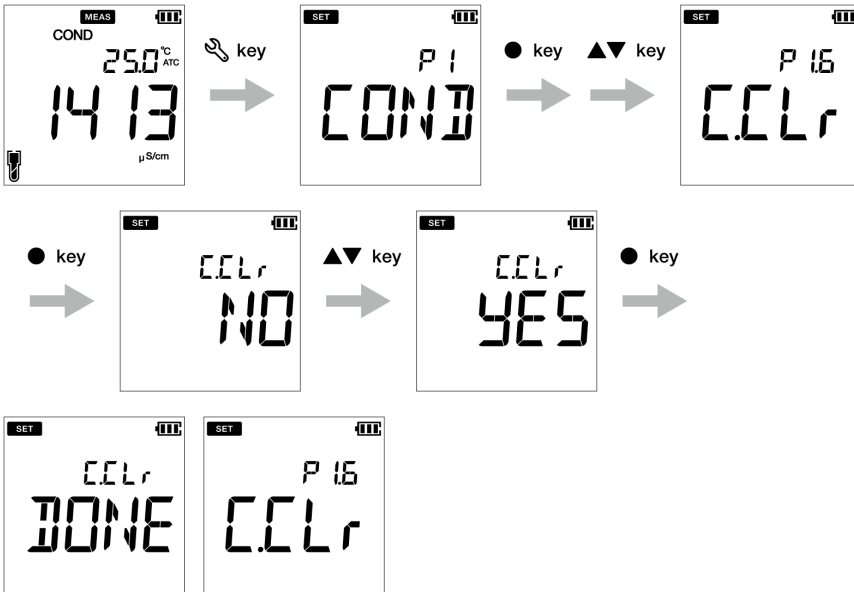

### ● P2 TDS setup

Using P2 TDS setup function of the meter, you can:

- Select TDS curve
- Select TDS unit
- Erase calibration data

To set the TDS functions using LAQUA PC200 handheld meter, follow the procedure detailed below:

#### Prerequisites

Switch on the PC meter.

---

#### Note

- Default TDS curve is **linear**. You can change the TDS curve to 442 or EN27888 or NaCl.
  - For linear curve, default multiplier factor is **FACT 0.50**. You can set a multiplier factor in between 0.40 to 1.00.
  - Default TDS unit is set as **mg/L** (g/L). You can change the unit to ppm (ppt).
  - Erasing previous calibration data is recommended for accurate calibration. Default setup is **NO** but to erase the calibration data, you need to change the setup to **YES**.
- 









---

#### Tip

To return to the measurement mode, press the  key.

---

• P 2.1 TDS curve selection



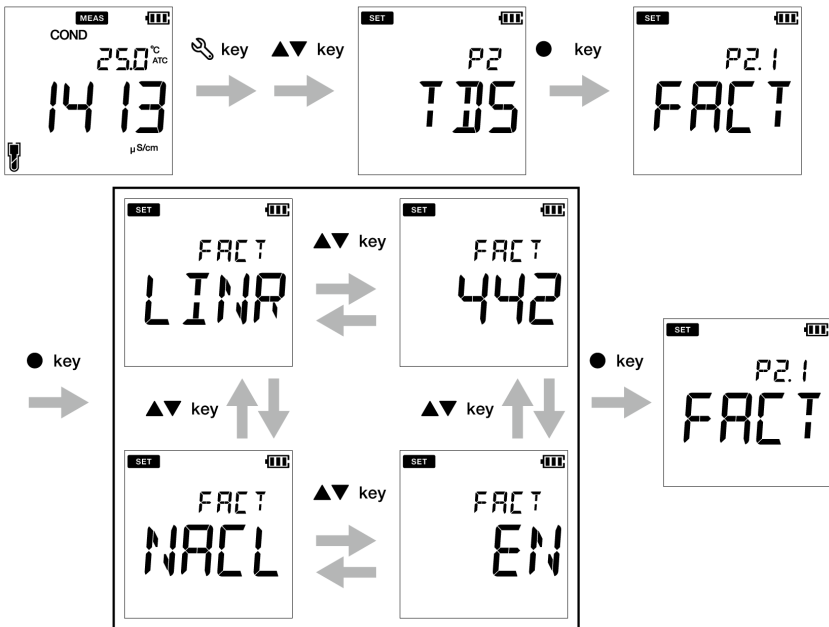



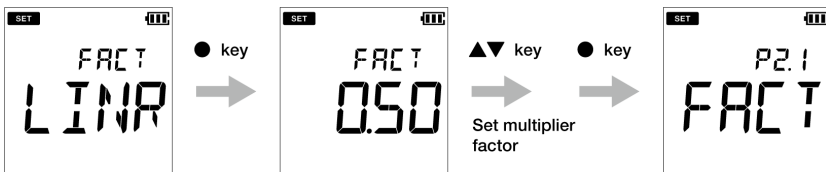

1. Press the  key, P1 COND screen appears.
2. Press the  key, P2 TDS screen appears
3. Press the ENT  key, P2.1 FACT screen appears.
4. Press the ENT  key, by default FACT LINR appears.
5. Use the   keys to select a TDS curve and press the ENT  key.
6. While selecting the linear curve, set a fact in between 0.40 to 1.00.
7. Press the ENT  key, P2.1 FACT screen appears. This indicates completion of TDS curve setup.



If you choose LINR, you can select a factor from 0.40 to 1.00.



● **P 2.2 Select TDS unit**

1. Press the  key, **P1 COND** screen appears.
2. Press the  key, **P2 TDS** screen appears.
3. Press the **ENT**  key, **P2.1 FACT** screen appears.
4. Press the  key, **P2.2 UNIT** screen appears.
5. Press the **ENT**  key, **UNIT mg/L (g/L)** screen appears
6. Use the   keys to change the TDS unit to ppm (ppt).
7. Press the **ENT**  key, **P2.2 UNIT** screen appears. This indicates completion of TDS unit selection.

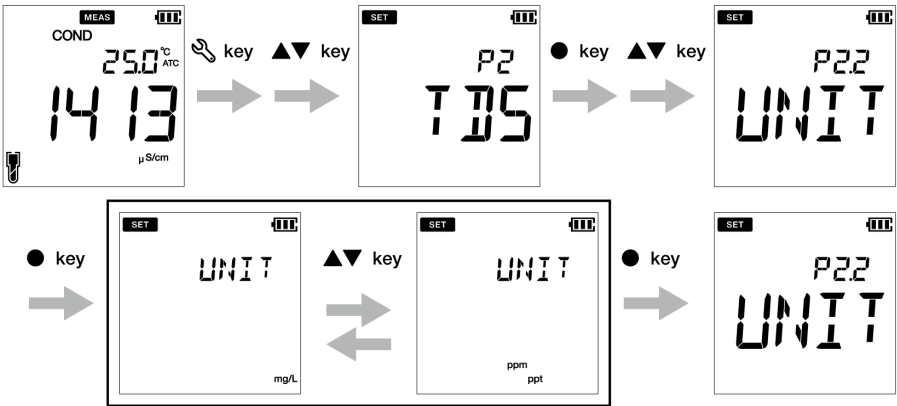

1. P3 SAL setup

Using P3 SAL setups function of the meter, you can:

- Select salinity unit
- Select salinity curve
- Erase calibration data

To set the salinity functions using LAQUA PC220 handheld meter, follow the procedure detailed below:

**Prerequisites**

Switch on the PC meter.

---

**Note**

- Default salinity unit is set as **ppt**. You can change the unit to **percentage (%)**.
  - Default salinity type is set as **NaCl**. You can change the salinity type to seawater.
  - Erasing previous calibration data is recommended for accurate calibration. Default setup is **NO** but to erase the calibration data, you need to change the setup to **YES**.
- 









---

**Tip**

To return to the measurement mode, press the  key.







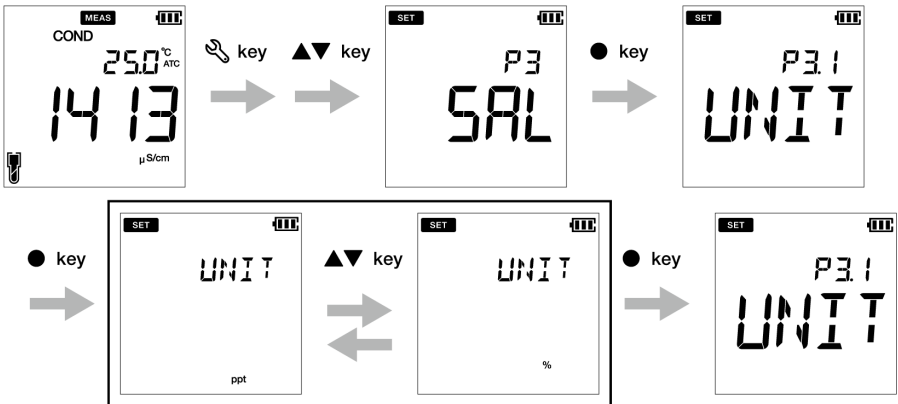

---

● **P 3.1 select salinity unit**

2. Press the  key, **P1 COND** screen appears.
3. Press the  key, **P2 TDS** screen appears.
4. Press the  key, **P3 SAL** screen appears.
5. Press the **ENT**  key, **P3.1 UNIT** screen appears.
6. Press the **ENT**  key, by default **UNIT ppt** appears.
7. Use the   keys to change the salinity unit to percentage (%).
8. Press the **ENT**  key, **P3.1 UNIT** screen appears. This indicates completion of salinity unit selection.







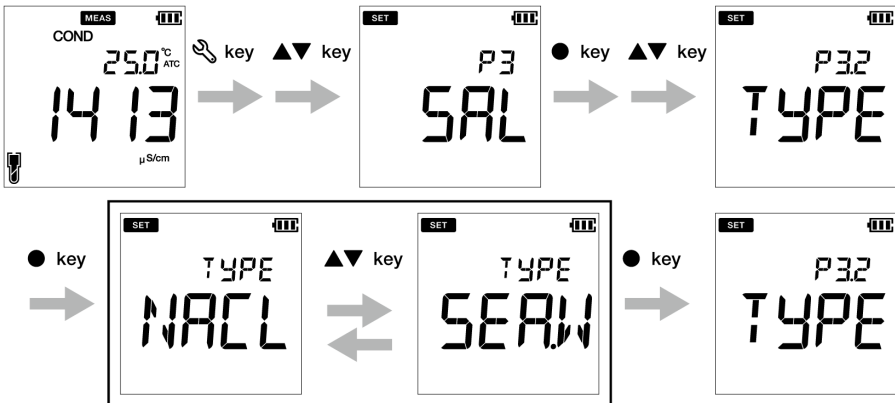





### • P 3.2 select salinity type

1. Press the  key, **P1 COND** screen appears.
2. Press the  key, **P2 TDS** screen appears.
3. Press the  key, **P3 SAL** screen appears.
4. Press the **ENT**  key, **P3.1 UNIT** screen appears.
5. Press the  key, **P3.2 TYPE** screen appears.
6. Press the **ENT**  key, **TYPE NAACL** appears with NaCl as default setup.
7. Use the   keys to change the salinity type to seawater.
8. Press the **ENT**  key, **P3.2 TYPE** screen appears. This indicates completion of salinity type selection.



● **P 3.3 Erase calibration data**

1. Press the  key, **P1 COND** screen appears.
2. Press the  key, **P2 TDS** screen appears.
3. Press the  key, **P3 SAL** screen appears.
4. Press the **ENT**  key, **P3.1 UNIT** screen appears.
5. Press the  key, **P3.2 TYPE** screen appears.
6. Press the  key, **P3.3 C.Clr** screen appears.
7. Press the **ENT**  key, **C.Clr NO** appears with **NO** as default setup.
7. Use the   keys to change the setup to **YES**. This erases the calibration data.
8. Press the **ENT**  key. **P3.3 C.CLR** screen appears. This indicates erasure of calibration data.

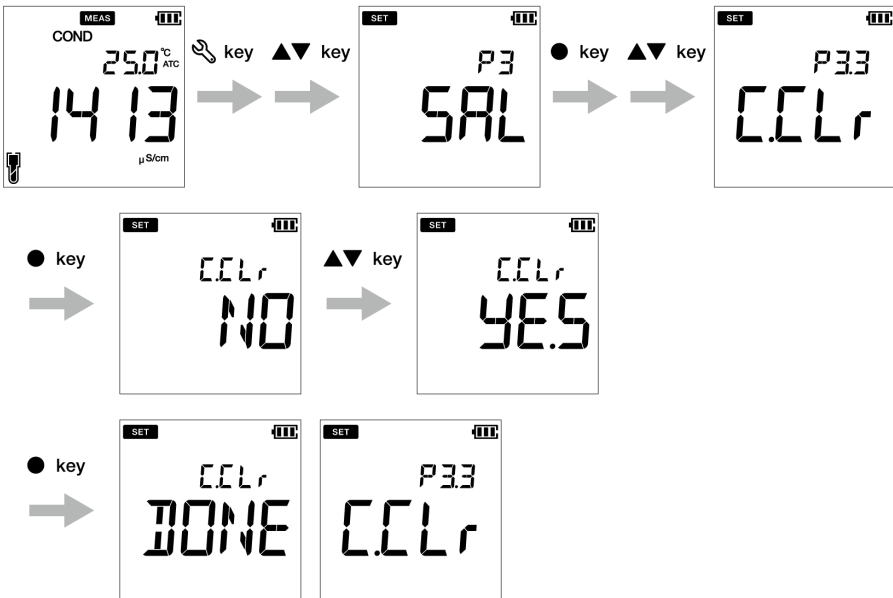



---

## • Data setup

Using Data setup function of the meter, you can:

- Set data log interval
- Print data log
- Erase data log

To set the data functions using LAQUA PC200 handheld meter, follow the procedure detailed below:

### Prerequisites

- Switch on the PC meter.
- Keep the meter either in pH or EC mode

---

### Note

- Data setup procedure is common in both pH and EC mode with different meter screen display based on available setup sequence.
  - Default data log interval is ----, where ---- indicates “no data log interval” has been set.
  - Data log interval can be set from 2 to 999 seconds.
- 







---

### Tip

To return to the measurement mode, press the  key.

---

• **Data log interval setup**

1. Press the  key, **P1 PH/EC** screen appears.
2. Press the  key, **P2/P4 DATA** screen appears.
3. Press the **ENT**  key, **P2.1/P4.1 LOG** screen appears.
4. Press the **ENT**  key, previously set log interval appears.
5. Use the   keys to set the data log interval.
6. Press the **ENT**  key, **P2.1/P4.1 LOG** screen appears. This indicates completion of data log interval setup.



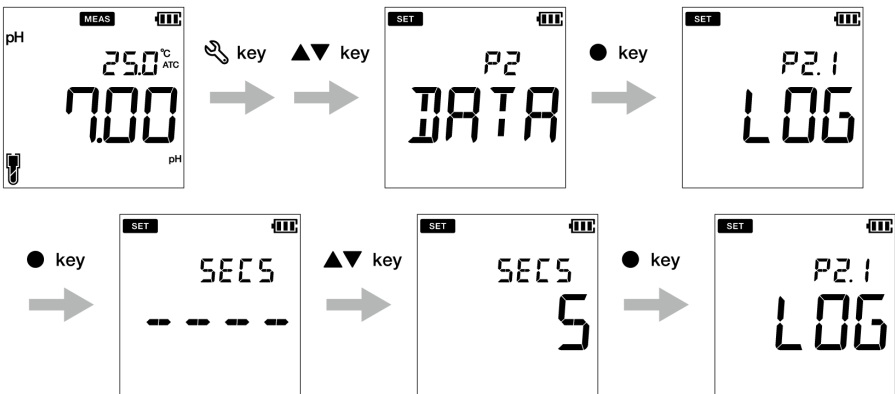



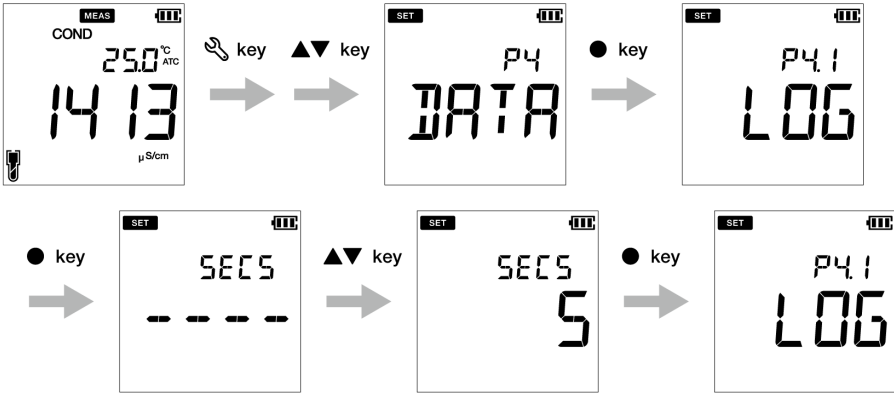

**pH mode**



## EC mode



● **Print data setup**

1. Press the  key, **P1 PH/EC** screen appears.
2. Press the  key, **P2/P4 DATA** screen appears.
3. Press the **ENT**  key, **P2.1 LOG** screen appears.
4. Press the  key, **P2.2/P4.2 PrNT** screen appears.
5. Press the **ENT**  key, default setup is **NO**.
6. Use the   keys to change the setup to **YES**.
7. Press the **ENT**  key, **P2.2/P4.2 PrNT** screen appears. This indicates completion of the print data.



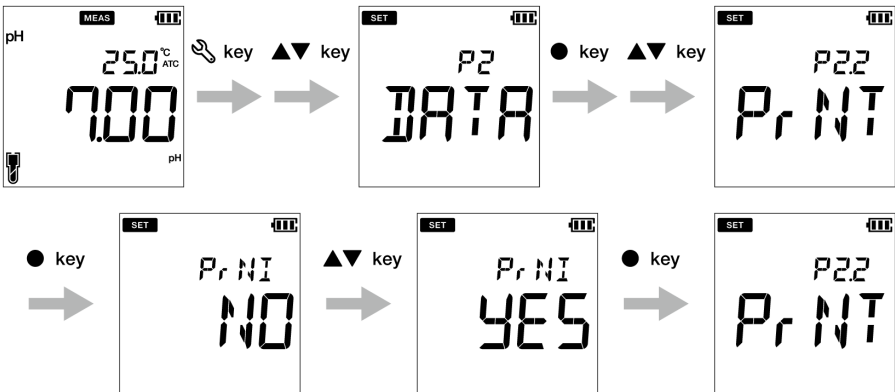



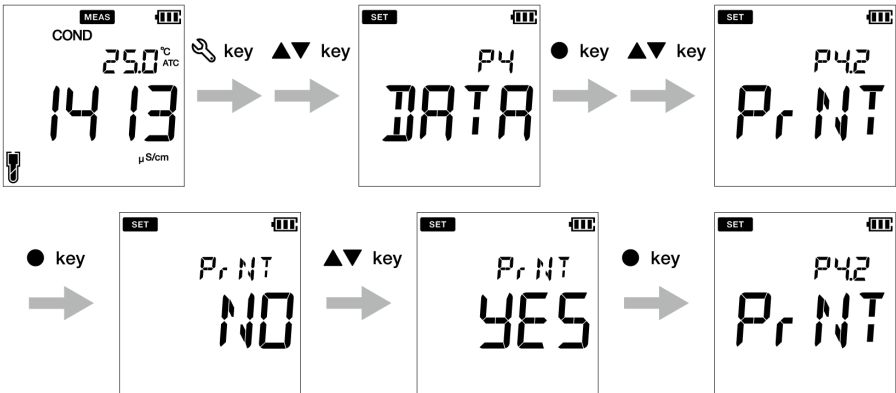

**pH mode**



## EC mode



• Erase data

1. Press the  key, P1 PH/EC screen appears.
2. Press  key, P2/P4 DATA screen appears.
3. Press the ENT  key, P2.1/P4.1 LOG screen appears.
4. Press the  key, P2.2/P4.2 PRNT screen appears.
5. Press the  key, P2.3/P4.3 D.CLR screen appears.
6. Press the ENT  key, default setup is NO.
7. Use the   keys set it to YES to erase all the data.
8. Press the ENT  key, D.CLR DONE screen appears briefly and then P2.3/P4.3 D.CLR screen appears. This indicates completion of erasure of data.

pH mode

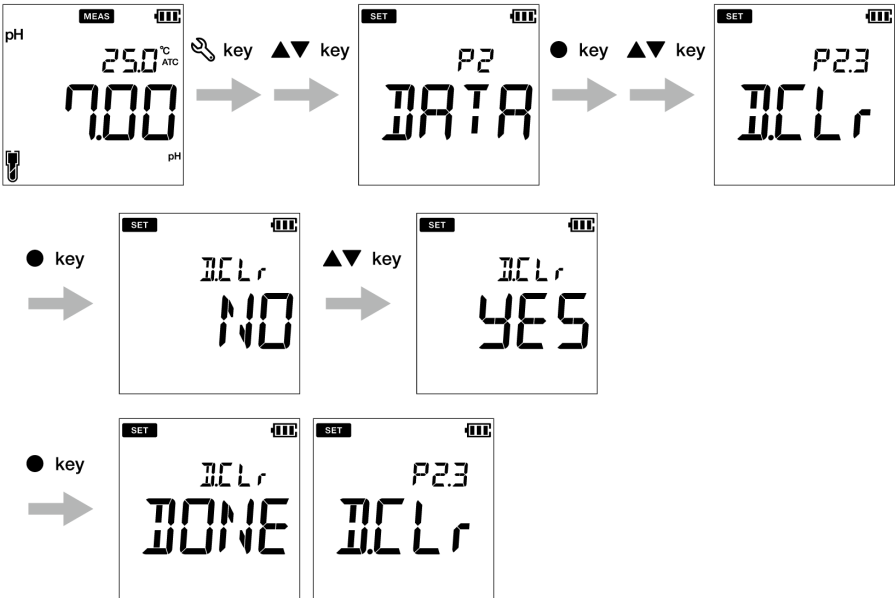

EC mode

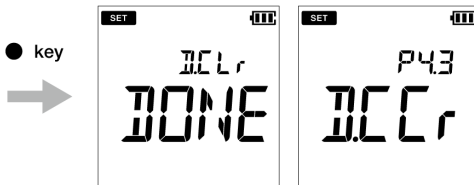
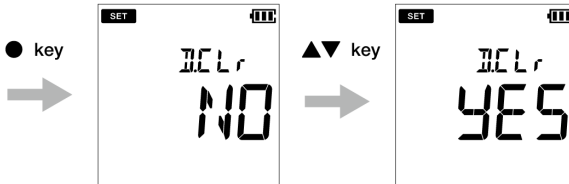
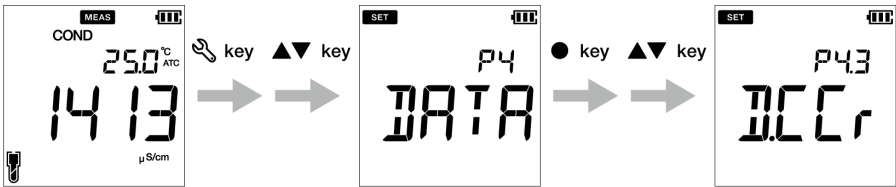

### ● General setup

Using P3 General setup function of the meter, you can:

- Select stability mode of the meter
- Set auto shut-off time
- Select temperature measurement
- Reset the meter

To set the general functions using LAQUA PC200 handheld meter, follow the procedure detailed below:

### Prerequisites

- Switch on the PC meter.
- Keep the meter either in pH or EC mode

---

### Note

- General setup procedure is common in both pH and EC mode with different meter screen display based on available setup sequence.
- In the calibration mode, the auto stable (**AS**) mode is activated. Default stability setup in measurement mode is “auto stable” (**AS**). If you like, you can change it to “auto hold” (**AH**) or “real time” (**RT**).
- Default auto shut-off time is 30 minutes. You can set the time from ---- to 30 minutes, where ---- indicates “no auto shut-off time” has been set and meter will be on continuously.
- Default temperature unit is °C and you can change the unit to °F.
- Default reset meter setup is **NO**. If you like to reset the meter, you can change it to **YES**.

---

### Tip

- Stability judgment criteria remains same for both auto stability mode and auto hold mode.
  - To return to the measurement mode, press the  key.
-











• **Auto Stable, Auto Hold and Real Time mode setup**

**Auto Stable (AS) mode** - the meter shows live readings ☺ annunciator blinks until the reading is stable.

**Auto Hold (AH) mode** - the meter locks the stable reading; ☺ annunciator blinks until reading is stable and then **HOLD** lights up.

**Real Time (RT) mode** - the meter shows live readings; Both ☺ and **HOLD** annunciators are inactive.

1. Press the  key, **P1 PH/EC** screen appears.
2. Press  key, **P2 DATA** screen appears.
3. Press  key, **P3/P5 GEN** screen appears.
4. Press the **ENT**  key, **P3.1/P5.1 STBL** screen appears.
5. Press the **ENT**  key, Default the stability mode is **AS** (auto stable).
6. Use the   keys to change the stability mode as **AH** (auto hold) or **RT** (real time).
7. Press the **ENT**  key, **P3.1/P5.1 STBL** screen appears. This indicates completion of the stability mode selection.

**pH mode**

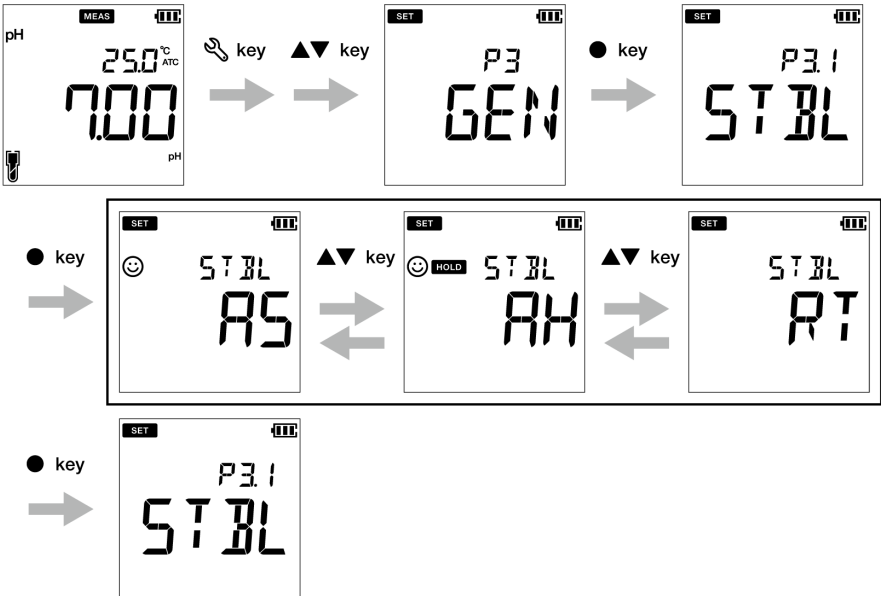





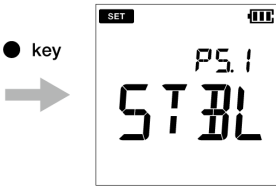
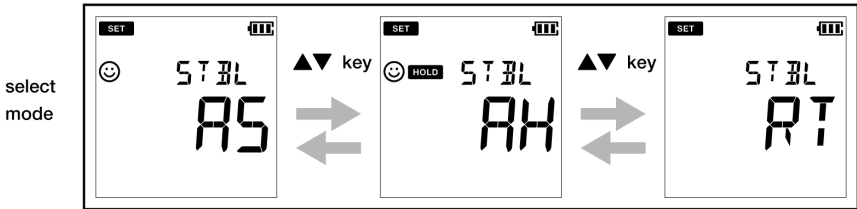
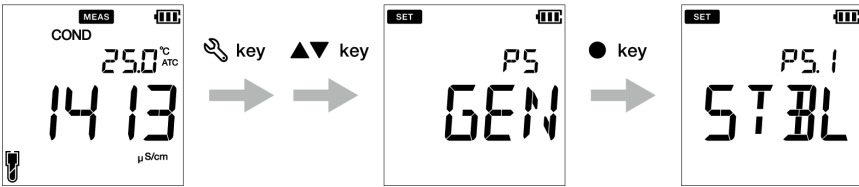



General set up

EC mode



### • Auto shut-off time setup

1. Press the  key, **P1 PH/EC** screen appears.
2. Press the  key, **P2 DATA** screen appears.
3. Press the  key, **P3/P5 GEN** screen appears.
4. Press the **ENT**  key, **P3.1/P5.1 STBL** screen appears.
5. Press the  key, **P3.2/P5.2 A.OFF** screen appears.
6. Press the **ENT**  key, default auto shut-off time is **30 minutes**.
7. Use the   keys to adjust the auto off time.
8. Press the **ENT**  key, **P3.2/P5.2 A.OFF** screen appears. This indicates completion of the auto shut-off time setup.

### Note

The default shut off time is 30 minutes. This can be adjusted from 1 minute to 30 minutes. If you set the display to '----' it indicates Auto Off is disabled. Meter will be on indefinitely till the user switches off the meter.



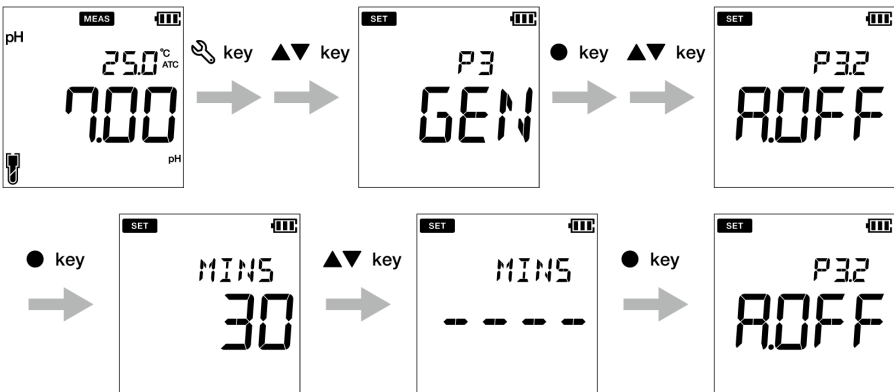



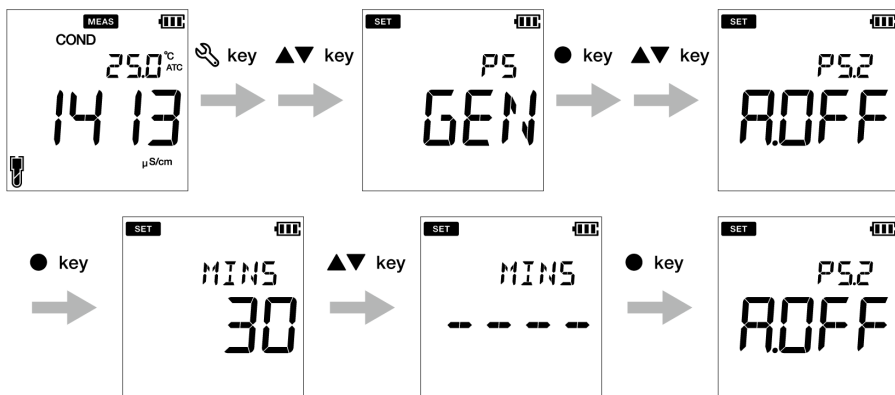



### pH mode



EC mode



• Temperature unit setup

1. Press the  key, **P1 PH/EC** screen appears.
2. Press the  key, **P2 DATA** screen appears.
3. Press the  key, **P3/P5 GEN** screen appears.
4. Press the  key, **P3.1/P5.1 STBL** screen appears.
5. Press the  key, **P3.2/P5.2 A.OFF** screen appears.
6. Press the  key, **P3.3/P5.3 °C°F** screen appears.
7. Press the **ENT**  key, default temperature unit is °C.
8. Use the   keys to change the unit to °F.
9. Press the **ENT**  key, **P3.3/P5.3 °C°F** screen appears. This indicates completion of the end temperature unit selection.



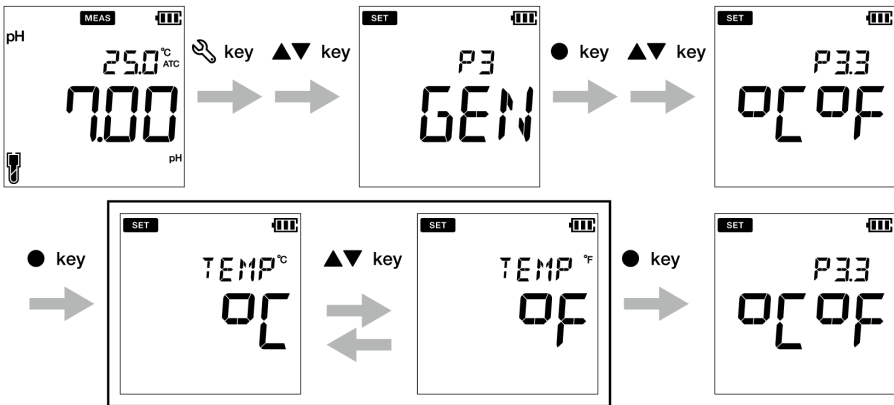



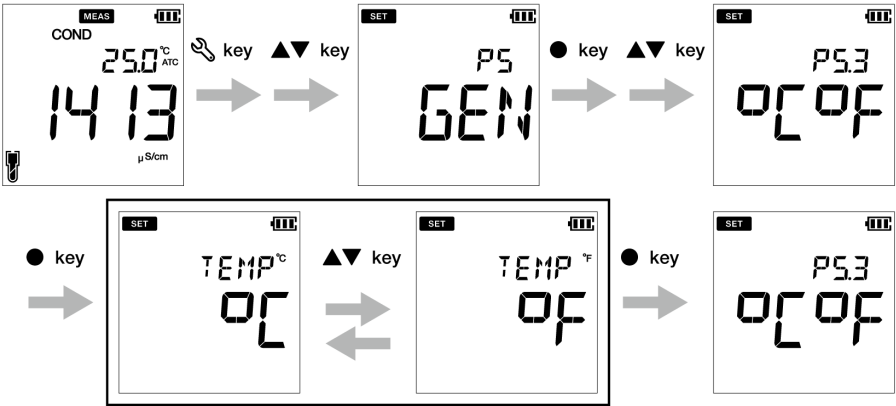



pH mode



EC mode



### • Reset meter (factory default)

1. Press the  key, **P1 PH/EC** screen appears.
2. Press the  key, **P2 DATA** screen appears.
3. Press the  key, **P3/P5 GEN** screen appears.
4. Press the **ENT**  key, **P3.1/P5.1 STBL** screen appears.
5. Press the  key, **P3.2/P5.2 A.OFF** screen appears.
6. Press the  key, **P3.3/P5.3 °C°F** screen appears.
7. Press the  key, **P3.4/P5.4 r.SET** screen appears.
8. Press the **ENT**  key, default meter re-setup is **NO**.
9. Use the   key to set it **YES**.
10. Press the  key. Meter displays **DONE** and automatically switches off.

### pH mode

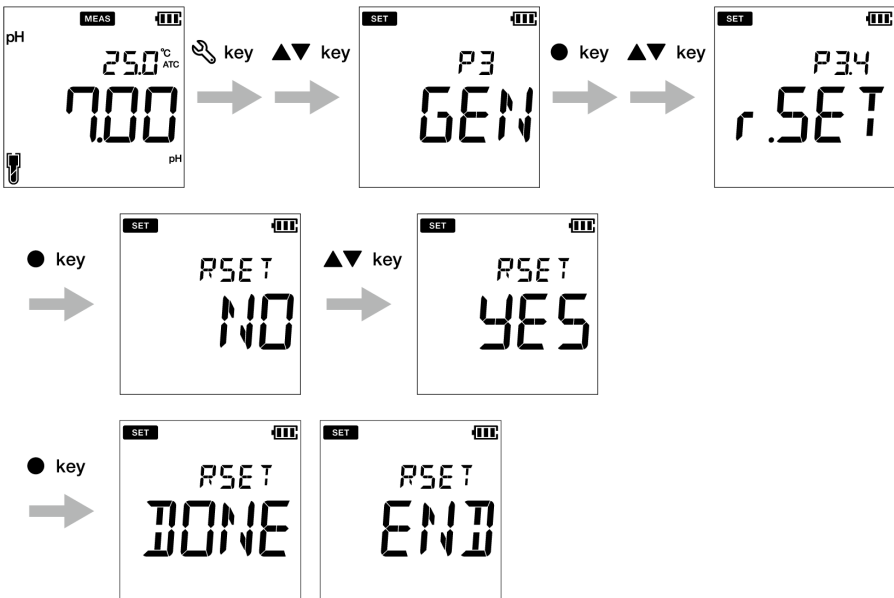

EC mode

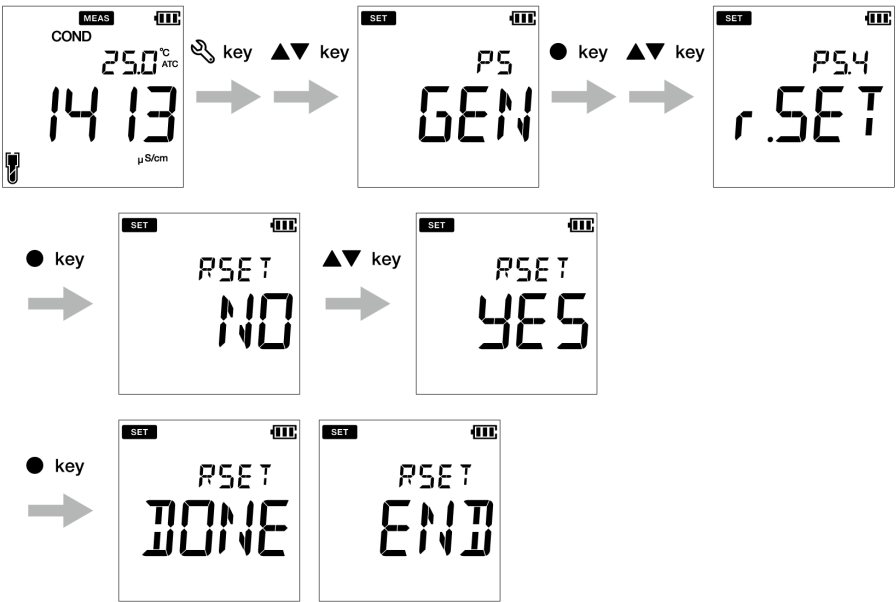



---

## • CLK setup

Real-time clock functionality is available only for LAQUA 220 meters. Using P4 Clock setup function of the meter, you can set:

- Date
- Time

To set the clock function using LAQUA PC220 handheld meter, follow the procedure detailed below:

### Prerequisites

- Switch on the PC meter.
- Keep the meter either in pH or EC mode

---

### Note

- Clock setup procedure is common in both pH and EC mode with different meter screen display based on available setup sequence.
- Setup date and time is necessary before using the instrument for the first time or after replacing the batteries.
- Set date and time data is captured correctly while saving data in the internal memory.















---

### Tip

To return to the measurement mode, press the  key.

---

• **Date setup**

1. Press the  key, **P1 PH/EC** screen appears.
2. Press the  key, **P2 DATA** screen appears.
3. Press the  key, **P3 GEN** screen appears.
4. Press the  key, **P4 CLK** screen appears.
5. Press the **ENT**  key, **P4.1 DATE** screen appears.
6. Press the **ENT**  key, default set year appears.
7. Use the   keys to adjust the year,
8. Press the **ENT**  key, default set month appears.
9. Use the   keys to adjust the month.
10. Press the **ENT**  key, default set day appears.
11. Use the   keys to adjust the day.
12. Press the **ENT**  key, **P4.1 DATE** screen appears. This indicates completion of the date setup.



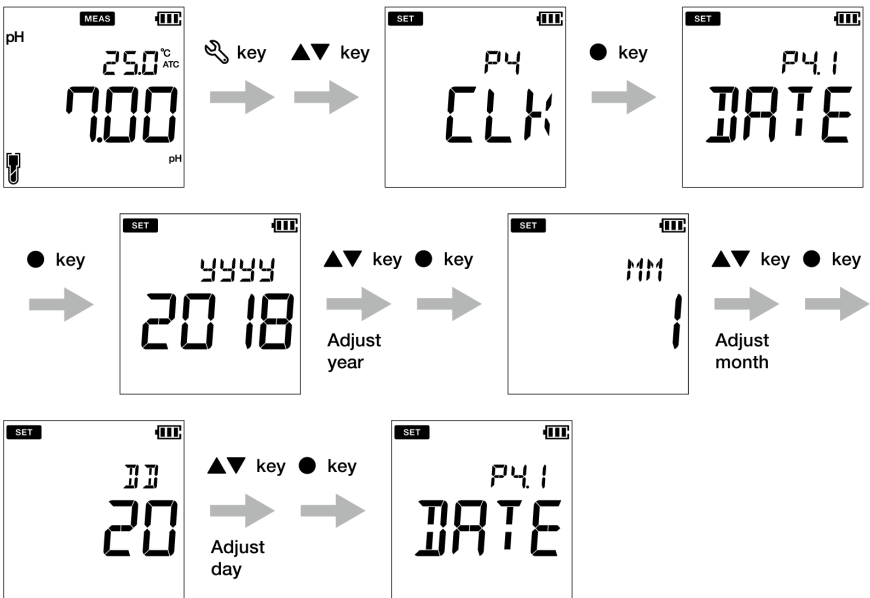



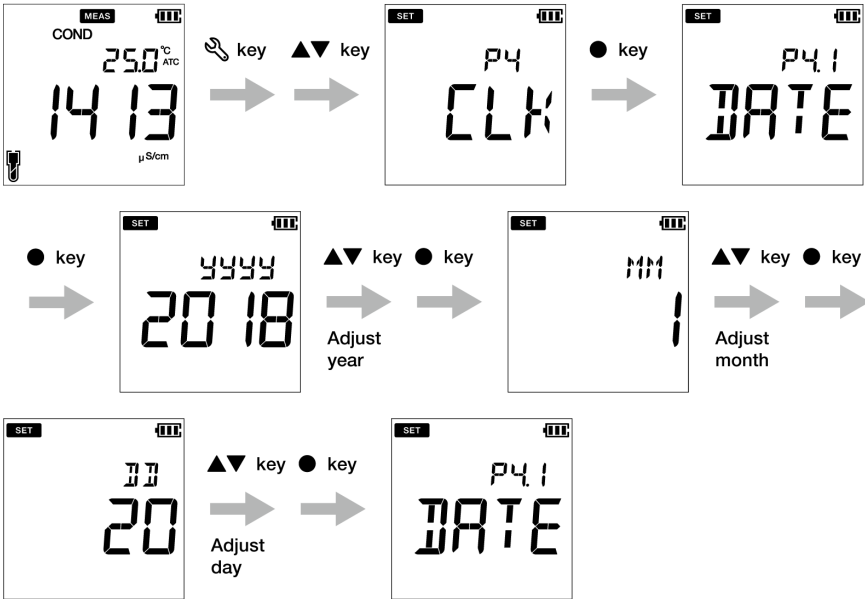





**pH mode**



EC mode



• Time setup

1. Press the  key to switch to the setup mode, **P1 PH/EC** screen appears.
2. Press the  key, **P2 DATA** screen appears.
3. Press the  key, **P3 GEN** screen appears.
4. Press the  key, **P4 CLK** screen appears.
5. Press the **ENT**  key, **P4.1 DATE** screen appears.
6. Press the  key, **P4.2 TIME** screen appears.
7. Press the **ENT**  key, default set hour appears.
8. Use the   keys to adjust the hour.
9. Press **ENT**  key, default set minute appears.
10. Use the   keys to adjust the minute.
11. Press **ENT**  key, **P4.2 TIME** screen appears. This indicates completion of the time setup.

pH mode

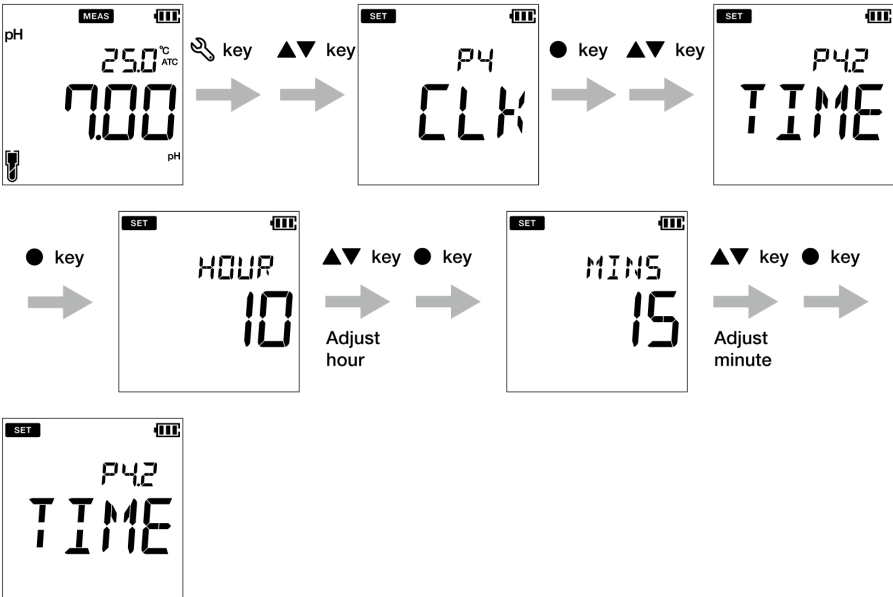

EC mode

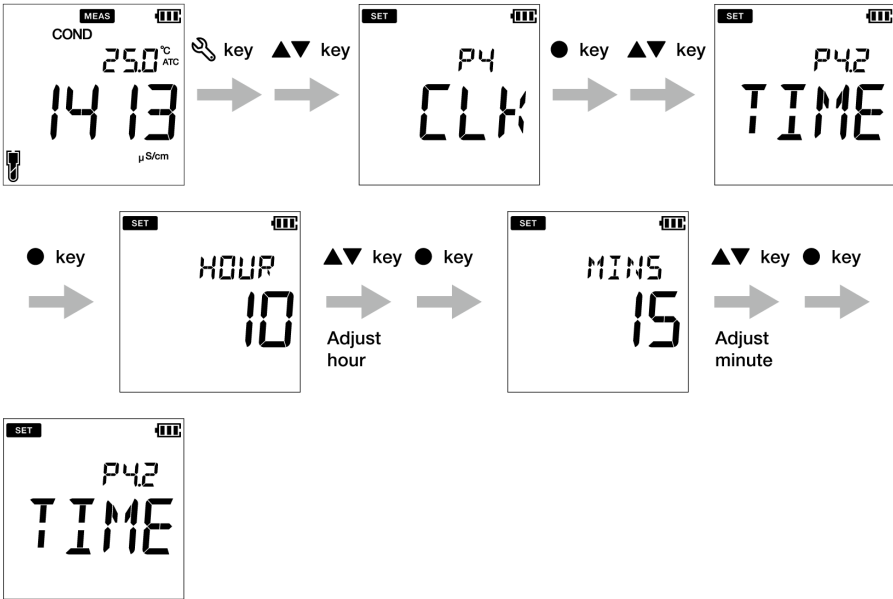

### ■ Maintenance and storage

This section describes maintenance of LAQUA PC200 handheld meter, pH, ORP and conductivity electrodes used with the meter.

#### ● Maintenance contract

Please contact your dealer for the product maintenance contract.

#### ● Maintenance and storage of the instrument

##### ● How to clean the instrument

- If the instrument is dirty, wipe it gently with a soft dry cloth. If it is difficult to remove the dirt, wipe it gently with a cloth moistened with alcohol.
- The instrument is made of solvent resistant materials but is not resistant to all chemicals. Do not dip the instrument in strong acid or alkali solution, or wipe it with such solutions.
- Do not wipe the instrument with polishing powder or other abrasive compound.

##### ● Environmental conditions for storage

- Temperature: 0 °C to 45 °C
- Humidity: under 80% relative humidity and free from condensation

##### ● Avoid the following conditions:

- Dusty place
- Strong vibration
- Direct sunlight
- Corrosive gas environment
- Close to an air-conditioner
- Direct wind

## ● Maintenance and storage of electrodes

This section describes an overview of the procedures for maintenance and storage of pH, ORP and conductivity electrodes.

### ● How to clean the electrodes

Always clean the electrode with deionized water after every measurement. When the response is slow or residue from the sample adheres to the electrode, use the appropriate method below to clean the electrode, and then clean again with deionized water.

#### For pH electrode

Type of dirt	Cleaning solution
General	Diluted neutral cleaning solution
Oil	Alcohol, or diluted neutral cleaning solution
Inorganic substance	1 mol/L HCl or electrode cleaning solution
Protein	Cleaning solution including protein-removing enzyme
Alkali	Dip in 1 mol/L HCl or electrode cleaning solution for 1h to 2 h

#### For ORP electrode

Type of dirt	Cleaning solution
General	Dilute neutral cleaning solution (General dish washing liquid works reasonably well.)
Oil	
Inorganic substance	Immerse dilute nitric acid (1:1 nitric acid)

#### For conductivity electrode

Type of dirt	Cleaning solution
General	Diluted neutral cleaning solution
Inorganic substance	Ethanol (keep the ethanol away from plastic parts)
Scale that formed during long term storage	A commercially available scale remover or dilute neutral cleaning solution. If this does not remove the scale, use diluted solution that contains oxygen bleach (sodium percarbonate) or chlorine bleach (sodium hypochlorite).

### ● Daily storage of the pH and ORP electrodes

If the electrode becomes dry, the response will be slow. Store in a moist atmosphere. Follow the steps below to properly store the electrodes even when the electrodes will not be used for a long period.

1. Wash the electrode well with pure water (or deionized water) to remove sample completely, and close the internal solution filler port.
2. Wash the inside of the protective cap with pure water (or deionized water), then add enough pure water (or deionized water) to soak the sponge.
3. Attach the protective cap.

### ● Daily storage of the conductivity electrode

If the electrode is stored in a dry state, the cell constant will change. Store with the black electrode part immersed in deionized water, or with the protective cap filled with deionized water and attached to the electrode.

To store the electrode for a long period, clean it well and attach the protective cap filled with deionized water.





## ■ Error messages and trouble shooting

### ● Error message

This section describes the causes of typical errors and the actions to be taken to resolve respective errors.

If ERR is displayed while you are using the instrument, check the error, its cause and action to be taken in the error list below:

Meter display	ERR description	Cause of error and How to solve the problem
<b>BATT LOW</b>	Low battery	Battery power is low. Please replace with new batteries.
<b>OFFS ERR</b>	Offset voltage error	Electrode is dirty or reference junction is clogged. Clean the electrode.
<b>SLPE ERR</b>	Slope error	Electrode sensitivity is low. Please clean and recalibrate with fresh standard solution. If the problem persists, replace the electrode with new one.
<b>BUFF ERR</b>	Can not auto recognize standard solution	The instrument cannot identify the standard solution. Check the calibration solution and use fresh one if required.
	Calibration interval alarm error	Exceeds the calibration interval setup. Calibrate the meter.
<b>MEM FULL</b>	Memory data full	The number of the data saved has exceeded the specified number of items. Print or transfer the data. Or, clear stored data.
	If user selects the enter key before stable in calibration mode	● key is pressed before the calibration value has stabilized. Wait for the value to be stable and then press the ● key.

● **Trouble shooting**

This section describes causes and actions to take for problems that customers frequently ask.

**The indicated value fluctuates**

**< Problem with the electrode >**

Cause	How to solve problem
The electrode is dirty.	Clean the electrode.
The electrode is cracked.	Replace the electrode.
The level of reference electrolyte gel.	Replace the electrode.

**< Problem with the instrument >**

Cause	How to solve problem
There is a motor or other device causing electrical interference.	Measure at a place where no influence from induction is given. Ground all AC-powered equipment.
The electrode is not connected correctly.	Connect the electrode properly.

**< Problem with the sample >**

Cause	How to solve problem
Electrode is not immersed enough to cover liquid junction.	The electrode must be immersed up to the liquid junction. As a guide, immerse to at least 3 cm from the tip of the electrode.
The stability of electrode is affected by the sample solution.	It is important to select an electrode that is appropriate for the sample. Consult your dealer. To confirm an electrode that is appropriate for the sample, check the electrode selection guide in our catalogue, or refer to our website.

**The response is slow**

<b>Cause</b>	<b>How to solve problem</b>
The electrode is dirty.	Clean the electrode.
The electrode is cracked.	Replace the electrode.
The response of electrode is affected by the sample solution.	It is important to select an electrode that is appropriate for the sample. Consult your dealer. To confirm an electrode that is appropriate for the sample, check the electrode selection guide in our catalogue, or refer to our website.

**The indicated value does not change/No response**

<b>Cause</b>	<b>How to solve problem</b>
The electrode is cracked.	Replace the electrode.
The electrode is not connected correctly.	Connect the electrode correctly.
Keys are locked.	Turn OFF the power, remove the batteries, and then turn ON the power again.
The instrument is in HOLD state.	Cancel the HOLD state.
Instrument defect	Consult your dealer.

### The measured value is out of the measurement range

When the measured value is below the display range, “Ur” appears. When the measured value is over the display range, “Or” appears.

Cause	How to solve problem
Sample is out of the measurement range.	Use a sample within the measurement range.
Electrode is not immersed enough to cover liquid junction.	The electrode must be immersed up to the liquid junction. As a guide, immerse to at least 3 cm from the tip of the electrode.
The electrode cable is broken.	Replace the electrode.
Calibration is not performed or performed incorrectly.	Perform calibration correctly.
Instrument defect	Check as explained below.

#### ● How to check for instrument defect (pH mode)

Short the metal part of the outer tube to the center pin of the electrode connector of the corresponding channel of the instrument. If “Ur” or “Or” appears in this condition, consult your dealer.

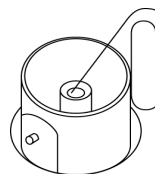

#### Repeatability of the measured value is poor

Cause	How to solve problem
Effect of the sample solution	Repeatability becomes poor when the pH of the sample changes over time.
The electrode is dirty.	Clean the electrode.
The electrode is cracked.	Replace the electrode.
The internal solution of the electrode is partially depleted or contaminated.	Replace the electrode.

**Nothing appears when the power is turned ON**

Cause	How to solve problem
Power is not supplied.	Insert batteries or connect the AC adapter (option).
Battery polarity (+, -) is reversed.	Insert the batteries with the polarity (+, -) correctly oriented.
Battery life is low.	Replace the batteries.
Instrument defect	Consult your dealer.

**Swelling of keypad**

Cause	How to solve problem
Using the instrument at high elevation or other location where the air pressure is different from sea level.	To eliminate the pressure difference between the inside and outside of the instrument, briefly open and then close the serial connector and battery cover. After opening, correctly close the cover to maintain dust and water proofing.
Instrument defect	Consult your dealer.

**Part of the display is missing**

Cause	How to solve problem
Instrument defect	Check the display by switching ON the instrument when all the LCD segments are lit.

■ **Appendix**

● **Appendix 1**

This section describes technical information and option for LAQUA PC200 handheld meters.

**The pH vs. temperature values for the various standards are listed below:**

< USA >

Temp. (°C)	pH 1.68	pH 4.01	pH 7.00	pH 10.01	pH 12.46
0	1.67	4.01	7.12	10.32	
5	1.67	4.01	7.09	10.25	13.25
10	1.67	4.00	7.06	10.18	13.03
15	1.67	4.00	7.04	10.12	
20	1.68	4.00	7.02	10.06	12.64
25	1.68	4.01	7.000	10.01	12.46
30	1.69	4.01	6.98	9.97	12.29
35	1.69	4.02	6.98	9.93	
40	1.70	4.03	6.97	9.89	11.99
45	1.70	4.04	6.97	9.86	
50	1.71	4.06	6.97	9.83	11.73
55	1.72	4.08	6.97	9.81	

## &lt; NIST &gt;

Temp. (°C)	pH 1.68	pH 4.01	pH 6.86	pH 9.18	pH 12.46
0	1.67	4.00	6.98	9.46	
5	1.67	4.00	6.95	9.39	13.25
10	1.67	4.00	6.92	9.33	13.03
15	1.67	4.00	6.90	9.27	
20	1.68	4.00	6.88	9.22	12.64
25	1.68	4.01	6.86	9.18	12.46
30	1.69	4.01	6.85	9.14	12.29
35	1.69	4.02	6.84	9.10	
40	1.70	4.03	6.84	9.04	11.99
45	1.70	4.04	6.83	9.04	
50	1.71	4.06	6.83	9.01	11.73
55	1.72	4.08	6.83	8.99	

## &lt; DIN &gt;

Temp. (°C)	pH 1.09	pH 3.06	pH 4.65	pH 6.79	pH 9.23	pH 12.75
0	1.08	3.10	4.67	6.89	9.48	13.37
5	1.09	3.10	4.66	6.87	9.43	13.37
10	1.09	3.10	4.66	6.84	9.37	13.37
15	1.09	3.08	4.65	6.82	9.32	13.17
20	1.09	3.07	4.65	6.80	9.27	12.96
25	1.09	3.06	4.65	6.79	9.23	12.75
30	1.10	3.05	4.65	6.78	9.18	12.61
35	1.10	3.04	4.65	6.77	9.13	12.45
40	1.10	3.04	4.66	6.76	9.09	12.29
45	1.11	3.04	4.67	6.76	9.04	12.14
50	1.11	3.04	4.68	6.76	9.00	11.98
55	1.11	3.04	4.69	6.76	8.96	11.84

● **Conductivity standard values at various temperatures**

Temp. (°C)	Conductivity value at 25 °C			
	84.00 (μS/cm)	1413 (μS/cm)	12.88 (mS/cm)	111.8 (mS/cm)
0	64.01	776	7.15	65.4
5	65.00	896	8.22	74.1
10	67.00	1020	9.33	83.2
15	68.00	1147	10.48	92.5
16	70.00	1173	10.72	94.4
17	71.00	1199	10.95	96.3
18	73.00	1225	11.19	98.2
19	74.00	1251	11.43	100.2
20	76.00	1278	11.67	102.1
21	78.00	1305	11.91	104.0
22	79.00	1332	12.15	105.9
23	81.00	1359	12.39	107.9
24	82.00	1386	12.64	109.8
25	84.00	1413	12.88	111.8
26	86.00	1440	13.13	113.8
27	87.00	1467	13.37	115.7
28	89.00	1494	13.62	117.7
29	90.00	1521	13.87	119.7
30	92.00	1548	14.12	121.8
31	94.00	1575	14.37	123.9



**• Appendix 2****Printer format - Measurement****pH**

Meter Model	: HORIBA PC220
Serial Number	: 123456789
SW Revision	: 1.00
Date	: 20 Aug 2018
Time	: 10:10:28
Mode	: pH
pH	: 7.00 pH
mV	: 0.0 mV
Temperature	: 25.0 C (MAN)
Electrode Status	: Excellent
User Name	:
Signature	:

**mV**

Meter Model	: HORIBA PC220
Serial Number	: 123456789
SW Revision	: 1.00
Date	: 20 Aug 2018
Time	: 10:10:28
Mode	: mV
mV	: 0.0 mV
Temperature	: 25.0 C (MAN)
User Name	:
Signature	:

**Relative mV**

Meter Model	: HORIBA PC220
Serial Number	: 123456789
SW Revision	: 1.00
Date	: 20 Aug 2018
Time	: 10:10:28
Mode	: R. mV
R. mV	: 3.0 mV
Offset	: -3.0 mV
Temperature	: 25.0 C (MAN)
User Name	:
Signature	:

**Conductivity**

Meter Model	: HORIBA PC220
Serial Number	: 123456789
SW Revision	: 1.00
Date	: 20 Aug 2018
Time	: 10:10:28
Mode	: Conductivity
Cond	: 1413 us/cm
Temperature	: 25.0 C (MAN)
Electrode Status	: Excellent
User Name	:
Signature	:

**Resistivity**

Meter Model	: HORIBA PC220
Serial Number	: 123456789
SW Revision	: 1.00
Date	: 20 Aug 2018
Time	: 10:10:28
Mode	: Resistivity
Resistivity	: 1000 M-Ohm/cm
Temperature	: 25.0 C (MAN)
Electrode Status	:
User Name	:
Signature	:

**Salinity**

Meter Model	: HORIBA PC220
Serial Number	: 123456789
SW Revision	: 1.00
Date	: 20 Aug 2018
Time	: 10:10:28
Mode	: Salinity
Salinity	: 50.0 ppt
Temperature	: 25.0 C (MAN)
Electrode Status	: Excellent
User Name	:
Signature	:

**TDS**

Meter Model	: HORIBA PC220
Serial Number	: 123456789
SW Revision	: 1.00
Date	: 20 Aug 2018
Time	: 10:10:28
Mode	: TDS
TDS	: 1.23 g/L
Temperature	: 25.0 C (MAN)
Electrode Status	:
User Name	:
Signature	:

**Printer format - Data log**

Meter Model	: HORIBA PC220
Serial Number	: 123456789
SW Revision	: 1.00
User Name	:
Signature	:
Logged Data	
Location	: 2
Date	: 10 Aug 2018
Time	: 10:10:28
Mode	: pH
pH	: 7.00 pH
mV	: 0.0 mV
Temperature	: 25.0 C (MAN)
Electrode Status	: Excellent
Location	: 1
Date	: 10 Aug 2018
Time	: 10:09:28
Mode	: mV
mV	: 178.0 mV
Temperature	: 25.0 C (MAN)

**Printer format - Calibration****PH**

Meter Model	: HORIBA PC220
Serial Number	: 123456789
SW Revision	: 1.00
Date	: 20 Aug 2018
Time	: 10:10:28
Calibration data	
Cal Date	: 20 Jun 2018
Cal Time	: 10:10:10
Cal Points	: 4.01, 7.00, 10.01
Offset	: 0.0 mV
Avg Slope	: 98.2 %
Cal Temp.	: 25.0 C (ATC)
Electrode Status	: Excellent
User Name	:
Signature	:

**EC**

Meter Model	: HORIBA PC220
Serial Number	: 123456789
SW Revision	: 1.00
Date	: 20 Aug 2018
Time	: 10:10:28
Calibration data	
Cal Date	: 20 Jun 2018
Cal Time	: 10:10:10
Cal Points	: 84.0 uS. 1413 uS
Avg Cal Factor	: 1.022
Cal Temp.	: 25.0 C (ATC)
Electrode Status	: Excellent
User Name	:
Signature	:

● Appendix 3

Model	PC210	PC220
	pH/ORP/EC/TDS/Sal/Res/Temp (°C/°F)	
pH Range	-2.00 to 16.00 pH	
Resolution	0.01 pH	
Accuracy	±0.01 pH	
Calibration Points	USA & NIST (Up to 5), DIN (Up to 6)	
pH Buffer Groups	USA, NIST, DIN	
ORP Range	±2000 mV	
Resolution	0.1 mV (< ±1000 mV), 1 mV (≥ ±1000mV)	
Accuracy	±0.3 mV (< ±1000 mV), 0.3% of reading (≥ ±1000mV)	
Calibration Option	Yes	
Conductivity Range	µS/cm to 200.0 mS/cm (k=1.0)	
Resolution	0.05% full scale	
Accuracy	±0.6% full scale, ±1.5% full scale > 18.0 mS/cm	
Reference Temperature	15 to 30 °C (adjustable)	
Temperature Coefficient	0.00 to 10.00 %/°C	
Cell Constants	0.1, 1.0, 10.0	
Calibration Points	Up to 4 (Auto) / Up to 5 (Manual)	
Units	S/cm, S/m (Auto Ranging)	
Total Dissolved Solids (TDS) Range	ppm to 100 ppt (TDS factor=0.5)	
Resolution	0.01 ppm (mg/L) / 0.1 ppt (g/L)	
Accuracy	±0.1% full scale	
TDS Curves	Linear (0.40 to 1.00), EN27888, 442, NaCl	
Resistivity Range	0.000 Ω•cm to 20.0 MΩ•cm	
Resolution	0.05% full scale	
Accuracy	±0.6% full scale, ±1.5% full scale > 1.80 MΩ•cm	
Salinity Range	0.0 to 100.0 ppt / 0.00 to 10.00 %	
Resolution	0.1 ppt / 0.01%	
Accuracy	±0.2% full scale	
Salinity Curves	NaCl, Seawater	
Calibration Option	Yes	
Temperature Range	-30.0 to 130.0 °C / -22.0 to 266.0 °F	
Resolution	0.1 °C / °F	
Accuracy	± 0.5 °C / ± 0.9 °F	

Calibration Option	Yes	
	500	1000
Memory	500	1000
Auto Data Log	●	●
Real-time Clock	-	●
Date & Time Stamp	-	●
Auto Hold / Auto Stable / Real Time	●	●
Offset & Average Slope Display	●	●
Calibration Alarm (1 to 90 days)	●	●
Auto Shut-Off (1 to 30 mins.)	●	●
Electrode Status	●	●
Diagnostic Messages	●	●
Software Upgrade <sup>*1</sup>	●	●
PC Communication <sup>*1</sup>	-	●
Printer Communication <sup>*2</sup>	-	●
Meter Inputs	BNC, phono	
Display	Custom LCD with backlight	
Housing	IP67, shock & scratch resistant, non-slip	
Power Requirement	2 × AA batteries	
Battery Life	> 500 hours	
Dimensions	160 (L) × 80 (W) × 40.60 (H) mm	
Weight	Approx. 260 g (with batteries) / 216 g (without batteries)	

\* Meter kit with NIST pH buffers is available upon request. Add 'N' suffix to order code.

\*1 Via PC (USB) cable PN 3200779639

\*2 Via Printer (RS232) cable PN 3200779638

● **Table of conductivity cell range**

• Unit: S/m

Range	Cell constant		
	1000 m <sup>-1</sup>	100 m <sup>-1</sup>	10 m <sup>-1</sup>
20.0 to 200.0 S/m			
2.00 to 19.99 S/m			
0.200 to 1.999 S/m			
20.0 to 199.9 mS/m			
2.00 (0.00) to 19.99 mS/m			
0.200 (0.000) to 1.999 mS/m			
0.0 to 199.9 μS/m			

• Unit: S/cm

Range	Cell constant		
	10 cm <sup>-1</sup>	1 cm <sup>-1</sup>	0.1 cm <sup>-1</sup>
0.200 to 2.000 S/cm			
20.0 to 199.9 mS/cm			
2.00 to 19.99 mS/cm			
200 to 1999 μS/cm			
20.0 (0.0) to 199.9 μS/cm			
2.00 (0.00) to 19.99 μS/cm			
0.000 to 1.999 μS/cm			



● **Table of conductivity cell range (resistivity range)**

· Unit:  $\Omega \cdot m$

Range	Cell constant		
	$10 m^{-1}$	$100 m^{-1}$	$1000 m^{-1}$
0.200 to 2.000 $M\Omega \cdot m$			
20.0 to 199.9 $k\Omega \cdot m$			
2.00 to 19.99 $k\Omega \cdot m$			
0.200 to 1.999 $k\Omega \cdot m$			
20.0(0.0) to 199.9 $\Omega \cdot m$			
2.00(0.00) to 19.99 $\Omega \cdot m$			
0.000 to 1.999 $\Omega \cdot m$			

· Unit:  $\Omega \cdot cm$

Range	Cell constant		
	$0.1 cm^{-1}$	$1 cm^{-1}$	$10 cm^{-1}$
20.0 to 200.0 $M\Omega \cdot cm$			
2.00 to 19.99 $M\Omega \cdot cm$			
0.200 to 1.999 $M\Omega \cdot cm$			
20.0 to 199.9 $k\Omega \cdot cm$			
2.00 (0.00) to 19.99 $k\Omega \cdot cm$			
0.200 (0.000) to 1.999 $k\Omega \cdot cm$			
0.0 to 199.9 $\Omega \cdot cm$			



# **HORIBA**Advanced Techno

31, Miyanonishi-cho, Kisshoin Minami-ku, Kyoto 601-8306, Japan  
<http://www.horiba-adt.jp>

---

For any questions regarding this product, please contact your local agency, or inquire from the following website.  
[http://global.horiba.com/contact\\_e/index.htm](http://global.horiba.com/contact_e/index.htm)

---

